



Planning Guide & Price List
April 15, 2007

TABLE OF CONTENTS

GENERAL INFORMATION	2
TAYLOR FREIGHT PROGRAM	3
PRODUCT INFORMATION	4
EDGE DETAILS	5
HARDWARE	6
BASE MOLDINGS	7
TYPICAL CONFIGURATIONS	8-9
POWER/DATA ACCESS AND WIRE MANAGEMENT	10
STANDARD GROMMET LOCATIONS	10
TECHNO-COMPONENTS	11
WORKSPACE ACCESSORIES	12-13
DESKS - GENERAL INFORMATION	14-16
Desks	17-22
Table Desks	23-25
Conferencing Desks	26-28
Run-Off Desks	29-31
BRIDGES	32-33
RETURNS	34-35
Modular Returns Components	34
Preconfigured Returns	35
CORNER UNITS	36
CREDENZAS - GENERAL INFORMATION	37
Modular Credenzas Components	38
Preconfigured Credenzas	39-41
STORAGE AND WORKWALLS - GENERAL INFORMATION	42-44
Overhead Storage Top Units	45-46
Pediments	47
Paper Management Organizers	47
Storage Towers Lateral Files Full Height Storage Units	48-50
Bookcases	51-52
MOBILE PEDESTALS	53
MISCELLANEOUS COMPONENTS	53-54
OCCASIONAL TABLES	55-56
RECEPTION STATIONS	57-59

GENERAL INFORMATION

Order Information

Mail or fax all orders or inquires to:

The Taylor Desk Company
11020 Santa Fe Avenue
Lynwood, CA 90262
Phone: 310-631-6727
Fax: 310-604-3338
E-Mail: info@thetaylorcompanies.com

All orders are subject to acceptance by The Taylor Desk Company. Orders will not be released for production until all information is complete. Orders must include the following information:

- Quantity
- Model Number
- Wood Finish
- Hardware Style & Finish
- Left or right sitting, where applicable
- Grommet locations, where applicable
- Diagram for multi-component configurations & custom wire management

Pricing and specification information for the seating shown in the Paull Group brochure can be found in the Taylor Chair Price List. Please contact Customer Service for additional information.

Phone and E-Mail Orders

Taylor Desk accepts phone and e-mail orders; however, a mailed or faxed purchase order marked "confirming" must follow immediately. Duplication of an order not marked "confirming" is the responsibility of the customer.

GSA Contract

The Paull Group is on GSA Contract (#GS-28F-0047J). Please contact Customer Service or visit our website (www.thetaylorcompanies.com) for more details.

Special Orders

The Paull Group is among the most flexible casegoods series in the industry in accommodating specialized product requirements. Should a particular need arise requiring size modification or customization of product, please contact Customer Service for a quotation. A non-refundable, minimum deposit of 50% of the quoted price is required on all special orders. Orders requiring special materials or construction are not subject to cancellation and Taylor Desk will not accept return of such orders. Lead time for special orders will be quoted at the time the order is received.

Terms and Credit Policy

Terms are 2% 10 days, net 30 days. All prices are list prices, uncartoned (blanket wrap), F.O.B. Lynwood, CA. Freight charges are not included (see Taylor Freight Program, page 3). Prices are subject to change without notice and all orders are accepted subject to prices prevailing at time of shipment. Distribution of this price list does not constitute an offer to sell. New customers are required to complete and return a credit application in full and make a minimum deposit of 50% of their first order, unless other arrangements have been made.

Past due accounts of 10 days or more are subject to being placed on credit hold until satisfactory arrangements are made. Any account that has an unpaid invoice that is 30 days past due will be placed for collection. Notification will be sent at such time. The customer will be responsible for all collection costs in the event their account must be placed for collection.

Acknowledgements

Orders cannot be acknowledged until complete information is received (see Order Information above). Each order will be entered, scheduled into production, and invoiced based upon information in the acknowledgement. It is the customer's responsibility to check acknowledgements for accuracy. Immediately notify Taylor Desk in writing of any discrepancies. **The printed acknowledgement is the final agreement between Taylor Desk and the customer, superseding all previous communications regarding the order.**

Changes and Cancellations

Orders are not subject to change or cancellation once production has begun. Order revisions may be subject to schedule and price adjustments. The customer will be liable for the full price of any order which is cancelled or changed once production has begun.

Routing

We will ship via customer's carrier specified, where practical. If no instructions are received, we will ship via whatever carrier, in our opinion, is best. For your convenience, the Taylor Freight Program is an available routing option whereby a guaranteed freight cost will be added at the time of your invoice from Taylor Desk (see page 3).

Storage

Taylor Desk has made no provision for storage. If the customer is unable to accept delivery of furniture as scheduled, the customer has the sole responsibility to provide new shipping instructions and all costs related to the delay and/or storage of the product are the responsibility of the customer. **Taylor Desk is not responsible for the condition of product that is stored or installed in an environment where temperature and humidity are not controlled.**

Installation and Maintenance

Proper installation and maintenance of Taylor Desk casegoods is the responsibility of the customer. Improperly installed units can result in permanent damage and is not covered under product warranty.

Electrical Components

Electrical components are U.L. listed. Compliance with electrical and building codes are the sole responsibility of the customer.

Designs

Designs in our catalog and price list are the property of Taylor Desk. Taylor Desk reserves the exclusive right to produce and market them. Some of the designs in our catalog and price list have design patents pending. Anyone who duplicates or reproduces them will be liable for patent infringement. Taylor Desk retains the right to change, at any time, materials or construction methods which, in our opinion, will improve our product. All measurements in the catalog and price list are approximate.

10 Year Limited Warranty

The Taylor Desk Company (Taylor) warrants to the first purchaser for use that its merchandise is free of defects in material and workmanship for a period of ten (10) years from date of invoice, provided that such merchandise is listed in Taylor's current price list at the time of the claim. Taylor's obligation under this warranty is limited to repair or replacement, at its option, and such repair or replacement shall be the only remedy. Because wood is a natural product, variations in grain and finish color may occur. Therefore, Taylor cannot guarantee the matching of grain or color. Taylor is not responsible for damage due to transportation, improper handling, alteration, abuse, negligence, or damage that occurs during storage. Taylor shall not be liable for any incidental or consequential damages including, but not limited to, any expenses associated with the removal or installation of any defective merchandise covered by this warranty. Taylor makes no implied warranty of merchantability or fitness for any particular purpose. **ALL OTHER WARRANTIES, EXPRESSED OR IMPLIED, ARE EXCLUDED.**

Glass Tops

It is not recommended to place glass tops on wood tops because they create a moisture trap that could damage the wood surface. **The use of glass tops may void the product warranty should damage occur.**

Manufacturing Defects

Claims of manufacturing defects will not be entertained without prior inspection by a Taylor representative. Unauthorized deduction in payment of invoices will not be allowed without prior factory approval.

TAYLOR DESK FREIGHT PROGRAM

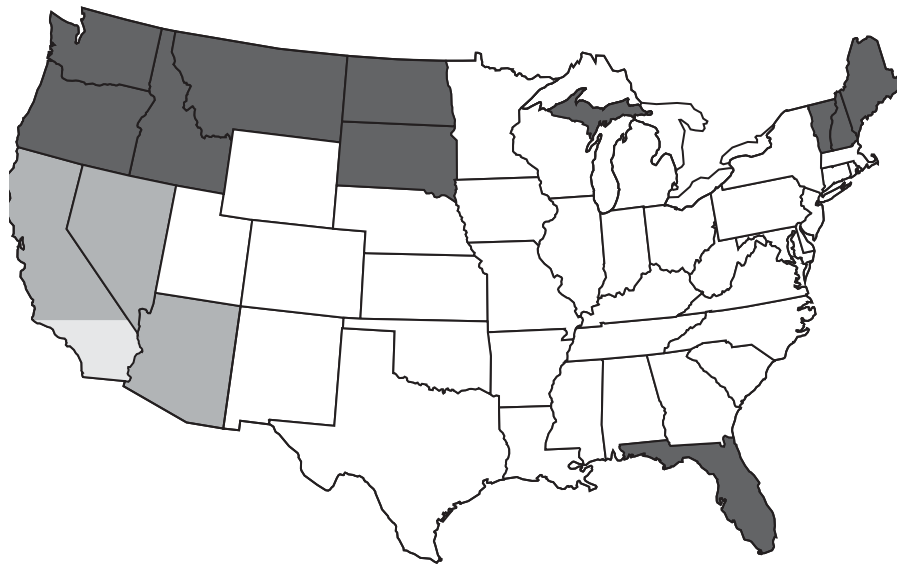

- ZONE 1:**
4% of the net order or \$240 net,
whichever is greater
- ZONE 2:**
6% of the net order or \$360 net,
whichever is greater
- ZONE 3:**
9% of the net order or \$540 net,
whichever is greater
- ZONE 4:**
10% of the net order or \$600 net,
whichever is greater

General Information

Taylor Desk offers a guaranteed freight rate through the optional Taylor Freight Program. All orders must be marked "**Taylor Freight Program**" and include accurate freight charges as a separate line item (see above). Invoicing for freight charges using this program will appear on the invoice for the order. This charge applies for dock-to-dock with "driver no touch" delivery to one destination only and does not include unloading or inside delivery. Taylor Desk reserves the right to select the carrier, and in most cases, will ship blanket wrapped.

The delivery location must be equipped with a dock and be fully accessible to a 53' tractor-trailer. The customer must provide all labor necessary to unload the shipment. **Customer must make certain that entrances, elevators, etc. are adequate for large units and/or tables.** Most items (except conference tables, workwalls, L-shape and U-shape desk configurations, etc.) are completely set up prior to shipping. Please contact Customer Service if desks need to be shipped partially assembled to accommodate an installation in close quarters.

Shipping Schedule

Taylor Desk is committed to the most prompt shipment possible of all its products. Taylor Desk assigns orders to a projected ship date for production purposes. Actual ship date may vary 3-5 working days for freight consolidation. Taylor Desk is not liable for failure to ship by the acknowledged shipping date or any other date. Taylor Desk is not liable for a delay or failure in shipment or performance if the delay or failure is caused by an act or omission of the customer; civil disturbances; dispute with or among labor unions; acts of God; delays in transportation; or other similar causes that are not within Taylor Desk's reasonable control.

Call Before Delivery

Since carriers charge back for call before delivery requests, an additional \$25 net charge will be added to orders that request a call before delivery.

Additional Charges

Rates are based on dock-to-dock "driver no touch" deliveries made Monday through Friday, 8 a.m. until 5:00 p.m. The dealer warehouse must also be specified on the order. Delivery direct to a jobsite, as well as date and time specific deliveries, may be arranged. In most cases, additional freight charges will incur. Contact Customer Service for quote on your delivery requirements. Any charges arising from failure to meet a shipment, rerouting while in transit, or carrier storage charges are NOT included in the pricing shown. Charges resulting from late deliveries beyond our control are not the responsibility of Taylor Desk.

Cartoning

If cartoning is requested, add 20% of the net price to each item as a separate charge on the order. There is no additional cartoning charge for occasional tables.

Freight Claims and Damaged Shipments

We take great care in the handling of our finished product. All Taylor Desk products are carefully inspected, protected with well-engineered packaging, and expertly loaded from our dock. All shipments are delivered to the carrier in good condition and our liability ceases at that time. **Therefore, we strongly recommend that all furniture be inspected immediately upon arrival.** If a shipment is received damaged, whether such damage is concealed or obvious, it is the purchaser's responsibility to properly note the damage. Do not refuse merchandise damaged in transit, as Taylor is not responsible for damage to goods that occur in transit or storage. If damage does occur, immediately follow these steps to expedite the claims process:

For Visible Damage:

1. Note damage on bill of lading (delivery receipt) and have driver sign.
2. Note damage on packing list.
3. Hold all packaging materials.
4. Contact Taylor Desk Customer Service to request Damage Notification Form.
5. Complete Damage Notification Form and return via fax to Taylor Desk within 5 days.

For Concealed Damage:

1. Open package and inspect contents within 5 days of receipt. (Carrier liability ceases after 5 days and the carrier will not be responsible for concealed damages.)
2. Follow steps 2-5 above.

If an item is determined to be field-repairable, please also submit a quotation for the repairs. **If repairs are made locally, repair charges will not be accepted unless approved in advance by Taylor Desk.**

Returns

No furniture may be returned for credit, inspection, or repair without first obtaining factory approval and a return authorization number. In the event of a credit by agreement, a handling charge of 30% will be deducted from the credit issued. **No furniture will be accepted unless a return authorization number is referenced and return transportation charges are prepaid. All furniture being returned must be properly packaged in its original or comparable replacement packaging to ensure protection of the product during handling and transportation.**

PRODUCT INFORMATION

Veneers

Hand selected, slip-matched Maple veneer is meticulously prepared and laid up onto the highest quality substrate in Taylor Desk's own Panel Department. All panels are produced using three-ply balanced construction to discourage warping.

Tops and Modesty Panels

All Paull Group tops are 1 1/4" thick, produced using three-ply balanced construction with solid Maple surrounding the top and shaped into one of eleven edge details. All top sizes are approximations. The Paull Group offers three distinct modesty styles: Recessed, Flush, and Step Front. All desk modesties and credenza backs are 3/4" thick, balanced construction, full height panels with meticulously book matched veneers.

Custom Capabilities

Taylor Desk has the capabilities to fulfill custom requirements for Paull Group. Please submit your written requirements and/or drawing to our Customer Service Department for a quotation.

Laminate Worksurfaces

As part of Taylor Desk's custom capabilities, HPL-laminate worksurfaces are available at a 10% upcharge, with a \$100 net minimum (a higher upcharge may apply to specially priced laminates). Purchase orders with a laminate option must include: **Manufacturer's Name, Laminate Name, and Number.**

Laminate tops will include a lumber edge in any standard edge detail. Taylor Desk will **not** automatically match the wood finish to the laminate selection. If a wood finish match is required, it must be specified and may require an additional special finish upcharge. Taylor Desk reserves the right to decline a laminate that may not be suitable for the application. Taylor Desk assumes no responsibility for the durability, consistent coloration, or any other performance characteristic of a customer-specified laminate. **Please contact Customer Service regarding laminate lead times, special finish requirements, and pricing.**

Drawers

All drawers are constructed as a four-sided box, using finger joint dovetailing. This technique ensures superior structural integrity and easy drawer front replacement. Drawer fronts are attached to the four-sided box and have vertically matched veneer over the entire set, ensuring each pedestal has a consistent appearance. Seven-ply laminated Maple is used for all drawer sides. Maple veneered bottoms are 1/4" thick and grooved into drawers on all sides. Drawer interiors are UV-lacquered for a smooth, durable finish.

Drawer Hardware

Drawer and door hardware is standard with Paull Group and is available in several styles and finishes. A side-routed finger pull (shaped into solid lumber edges for maximum strength) is also available. Refer to page 6 for a complete description of drawer and door hardware.

Drawer Suspensions

File drawers utilize full extension, progressive action ball bearing suspensions. The full extension slides offer maximum filing capacity. Box drawers utilize ball bearing suspensions with full extension.

Filing Capabilities

All file drawers are equipped with extruded aluminum hardware that can be easily configured to accept either letter or legal size filing. All desk, return, and credenza pedestals are legal width (except pedestals on 60" wide desks, which are letter width).

Adjustable Glides

Polymer glides with a threaded metal stem and "T" nuts, which are set in solid lumber, allow a 1" adjustment to accommodate uneven floors. Proper leveling is essential to the alignment and function of doors and drawers. Improperly leveled units may result in misaligned doors and drawers and may impair locking mechanisms or other functional hardware.

Locks

Locks are standard on all desk pedestals and lateral file units. Locks are also available on other pedestals and storage units as an option. Lateral file locks utilize an anti-tilt device for user safety. Removable lock cylinders provide for keying alike or re-keying in the field, which offers flexibility and security even when users change. When ordering furniture, list product by office and tag accordingly. Failure to assign and tag may result in random key number assignments.

Standard Finishes

Taylor Desk features a high quality, catalyzed lacquer finish, resulting in a beautiful, semi-filled, satin sheen surface. Careful attention is paid to the staining and shading process, however, due to the inherent varied characteristics of wood, certain variations will occur, thus emphasizing the natural beauty of real wood. **The finish samples provided by Taylor Desk represent the average color of the finish. Finishes may vary due to variations in wood grain, texture, and density. Taylor Desk cannot accept responsibility for the finish to remain true over a period of time.** Standard Paull Group finishes are:

AMB	Amber on Maple	ESP	Espresso on Maple
CML	Clear Maple	MHL	Mahogany on Maple
CHY	Cherry on Maple	COL	Clear Oak on Maple
RCL	Royal Cherry on Maple	SMK	Smoke on Maple
LWL	Light Walnut on Maple		

When ordering additional product for an existing installation, please submit a finish sample (i.e., drawer front) with your order since aging and mellowing of wood finishes occurs over time.

Special Finishes

Taylor Desk products are available with special finishes to commercially match the color of existing woodwork, architectural details, or other special conditions. Taylor Desk, however, cannot match the unique grain pattern of a particular species of wood. Submit a finish sample to be matched to the Taylor Desk Customer Service Department. A counter sample will be developed and returned for approval. Production will begin upon receipt of written approval of the sample.

Special finish orders are not cancelable. A one time, per color formulation charge of \$200 net, plus an upcharge per order, will be determined based upon complexity of the finish. If special finish orders involve both Taylor Desk and Taylor Chair, both Customer Service Departments should be notified to ensure proper coordination. Once a special finish has been formulated, it will be assigned a special finish number. To avoid another formulation charge, please be sure to specify this special finish number on future orders. Orders for discontinued finishes will be treated as special finishes and are subject to all special finish charges.

Finish Care and Protection

Taylor's catalyzed lacquer finishes should be maintained regularly by dusting with a soft, damp cloth. Polishing is not recommended more than 4-5 times per year and only with a high quality, non-silicone product. **Recommended products such as Murphy's Soap, Johnson's Pledge, or equivalents are formulated to contain degreasing agents, as well as cleaning additives that bring beauty to the wood.** Washing the wood with soap and water, all-purpose cleansers that contain bleach or ammonia, or with pure lemon oil is not recommended. These products will leave the finish lusterless and, in most cases, will cause harm to the finish.

Fine wood furniture should not be exposed to strong sunlight, heat outlets, open windows, or dampness. These environments may cause premature fading or warpage. When spills occur, they should be blotted up as quickly as possible. Avoid placing damp objects and hot items on surfaces without coasters. Consideration should be given to the continued use of synthetic or plastic pads which may cause a reaction to the finish. Taylor Desk is not responsible for markings on any surface caused by any writing instrument, as well as sharp or abrasive objects.

EDGE DETAILS

A selection of eleven distinct edge details are available on Paull Group worksurfaces and tops. Skillfully-crafted edge details are shaped into solid hard Maple lumber. To specify the edge detail selection, add the corresponding letter designation to the end of each model number.

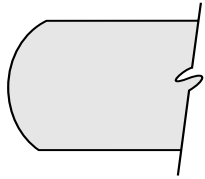

Arc (-AR)

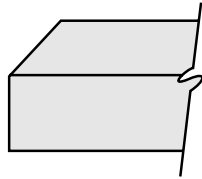

Bevel (-BV)

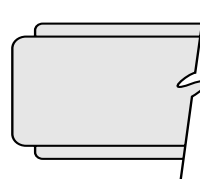

Classic (-CL)

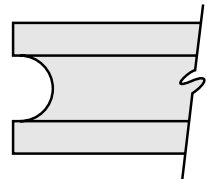

Cove (-CV)

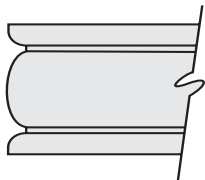

Ellipse (-EL)

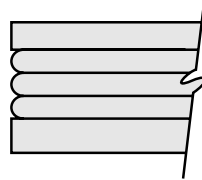

Fluted (-FL)

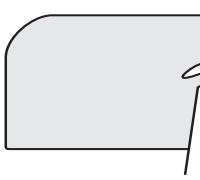

Radius (-RD)

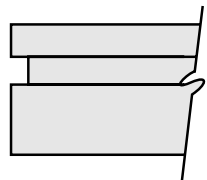

Reveal (-RE)

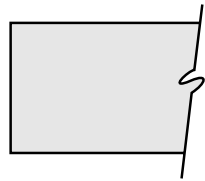

Square (-SQ)

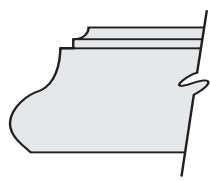

Traditional (-TD)

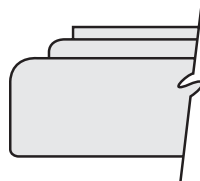

Transitional (-TR)

In some cases, inverse edge details are required to allow for flush mounting of returns, bridges, and other connecting components. The following inverse edge details will be included on adjacent worksurfaces, as required.

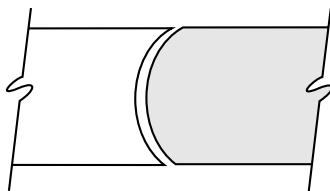

Arc (-AR)

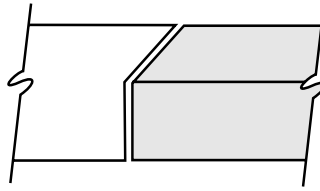

Bevel (-BV)

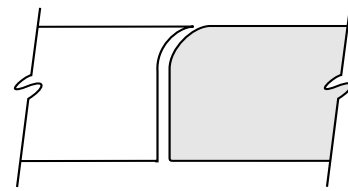

Radius (-RD)

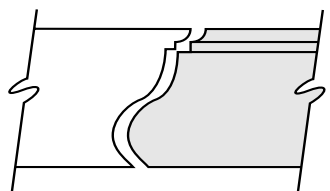

Traditional (-TD)

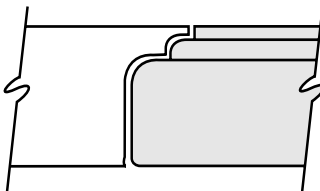

Transitional (-TR)

HARDWARE

Drawer and door hardware is standard with Paull Group (a side-routed finger pull is also available in lieu of hardware). Hardware is offered in six different styles with several finishes listed below. Drawings at right indicate hardware position. Knobs are used on Overhead Storage Units, unless otherwise indicated. Specify hardware selection by adding its corresponding letter designation to the end of each model number.

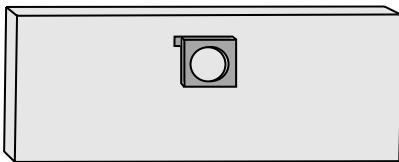

Cube Pull (-CU)
Satin Nickel (-SN)

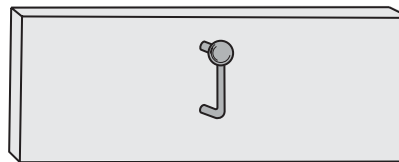

Orbit Pull (-OR)
Satin Nickel (-SN),
Matte Black (-MB),
Polished Chrome (-PC)

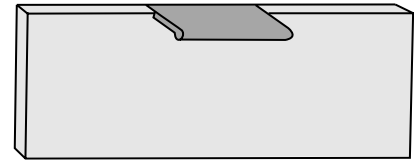

Tab Pull (-TA)
Satin Nickel (-SN),
Matte Black (-MB),
Polished Chrome (-PC),
Polished Brass (-PB)

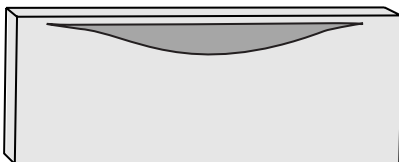

Swoop Pull (-SW)
Satin Nickel (-SN)
Matte Black (-MB)

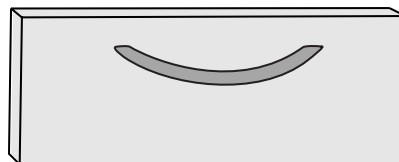

Arc Pull (-AR)
Satin Nickel (-SN),
Matte Black (-MB),
Polished Chrome (-PC)

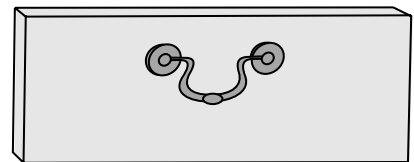

Heritage Pull (-HE)
Antique Brass (-AB)

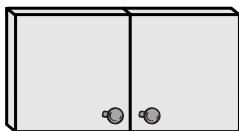

Orbit Knob (-OR)
Satin Nickel (-SN)
Matte Black (-MB),
Polished Chrome (-PC)

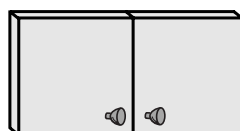

Arc Knob (-AR)
Satin Nickel (-SN),
Matte Black (-MB),
Polished Chrome (-PC)

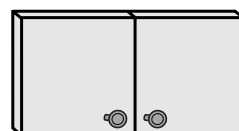

Heritage Knob (-HE)
Antique Brass (-AB)

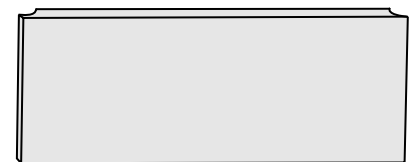

Side-Routed Finger Pull (-FP)

BASE MOLDINGS

Solid Maple Base Moldings are available as an option with Paull Group. Two styles are offered: Capitol Base Molding (**CAP-BASE-**) and Century Base Molding (**CEN-BASE-**). Placement of base molding differs on each Paull Group component (see drawings below, **bold line** indicates base molding). Specify base molding selection by adding the style name to the corresponding letter designation listed below, then add to list price (i.e., **CAP-BASE-WARD** for Capitol Base Molding on a Wardrobe Unit).

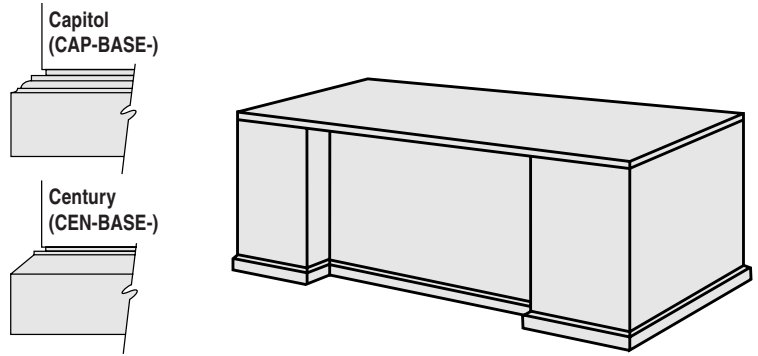

PRICING AND PLACEMENT

Desks:

Recessed, Double Ped Desk (- RECESS-DBL)	\$550
Recessed, Single Ped Desk (- RECESS-SGL)	500
Flush, Double Ped Desk (- FLUSH-DBL)	525
Flush, Single Ped Desk (- FLUSH-SGL)	475
Step, Double Ped Desk (- STEP-DBL)	575
Step, Single Ped Desk (- STEP-SGL)	525

Credenzas:

72" and smaller (- CREDS)	475
Over 72" (- CREDL)	525

Returns:

48" and smaller (- RETURNS)	395
Over 48" (- RETURNL)	425

Bridges:

36" and smaller (- BRIDGES)	215
Over 36" (- BRIDGEL)	250

Miscellaneous:

Single Lateral File (- LAT)	315
Wardrobe/Storage (- WARD)	350
Bookcase/Non-End-Run (- BC)	275
Square End-Run Bookcase (- SBC)	215
Quarter-Round End-Run Bookcase (- QBC)	250

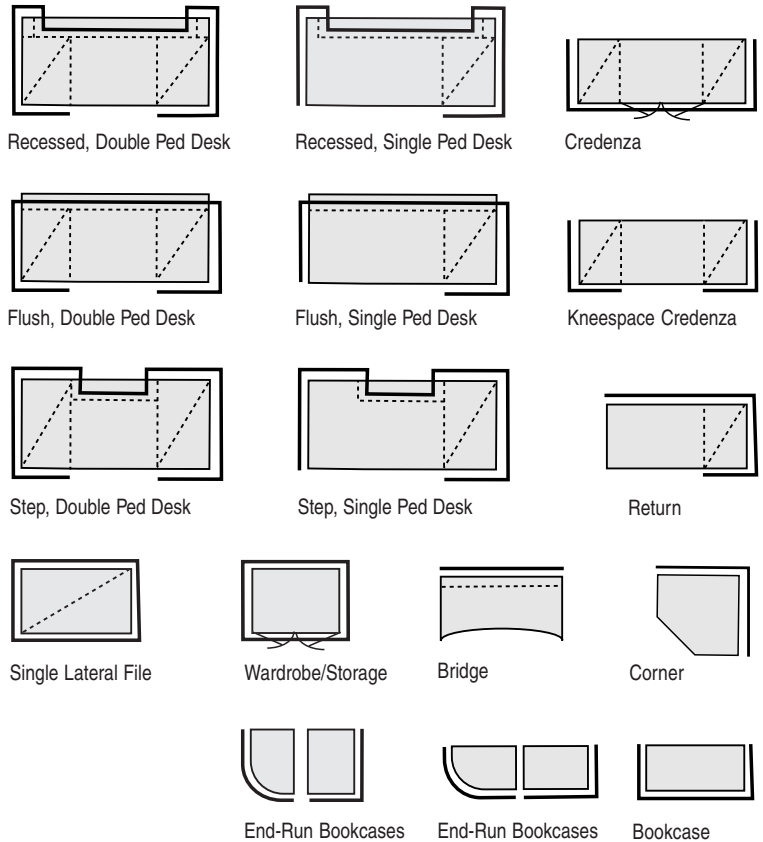

WORKWALL PLACEMENT

In some cases, it is necessary to eliminate base molding so that units may sit side-by-side without interference from the base molding. When specifying Paull Group with base molding for workwalls or other modular configurations, a diagram MUST be included. Customer Service will determine and notify you of the most appropriate locations for base moldings.

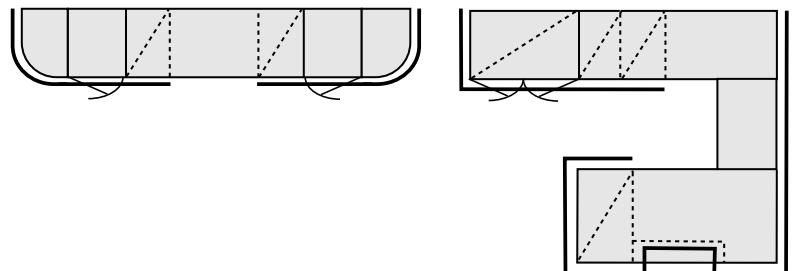

TYPICAL CONFIGURATIONS

These Typical Configurations illustrate some of the many possibilities available from Paull Group. Larger color photographs of the following configurations can be found in the Paull Group product brochure. In order to focus on the furniture components, **there are no options or accessories listed.**



Step Front Double Pedestal Desk	PG3672BB-S	\$3790
Preconfigured Credenza	PG2472BHDB	3320
Total		\$7,110



Step Front, Single Pedestal Desk (<i>Ped Right</i>)	PGPG3672SPB-S	\$3530
Open Metal Modesty	PGMOD-OPMTL	295
Brige Unit (<i>Left</i>)	PGB2448	1115
Preconfigured Credenza (<i>Ped Left</i>)	PG2472BKBS	2640
Top Unit w/ Paper Management Shelf	PG1572TPM	3060
Aluminum-Framed Frosted Glass Doors	INSET-AGL	1075
Lateral File Storage Unit (<i>Left</i>)	PG2436LFS	4365
Aluminum-Framed Frosted Glass Doors	INSET-AGL	975
Lateral File Storage Unit (<i>Right</i>)	PG2436LFS	4365
Aluminum-Framed Frosted Glass Doors	INSET-AGL	975
Total		\$22,395



P-Top Conferencing Desk w/ Wood Column (<i>P out on Left</i>)	PG3684CD-PTP-WDC	\$3495
Perforated Metal Modesty	PGMOD-PERFMTL	695
Curved Bridge Unit (<i>Right</i>)	PGBC2448	1250
Preconfigured Credenza (<i>Ped Right</i>)	PG2472BKBS	2640
Top Unit w/ Paper Management Shelf	PG1572TPM	3060
Paper Management Organizer (<i>Right</i>)	PG-PMO4-1	465
Lateral File Storage Unit	PG2436LFS	4365
Quarter-Round End-Run Bookcase (<i>Right</i>)	PGQBC2415-LEFT	2080
Total		\$18,050



Arc End Table Desk w/ Tapered Wood Leg	PG3678ARC-TAP	\$2960
Square End-Run Bookcase (<i>Left</i>)	PGSBC2415-LEFT	1910
Single Wardrobe Storage Unit (<i>Hinge Left</i>)	PG2424WS	2455
Preconfigured Credenza	PG2472FKSF	2995
Top Unit	PG1572T	2840
Paper Management Organizer (<i>Left</i>)	PG-PMO5-1	515
Paper Management Organizer (<i>Right</i>)	PG-PMO5-1	515
Single Storage Unit (<i>Hinge Right</i>)	PG2424FS	2565
Square End-Run Bookcase (<i>Right</i>)	PGSBC2415-RIGHT	1910
Total		\$18,665

TYPICAL CONFIGURATIONS



Sailfin Conferencing Desk w/ Tapered Wood Leg (Left Conference End)	PG3678CD-SLF-TAP	\$3550
Curved Bridge Unit (Right)	PGBC2436	1120
Curved Corner Unit	PG4242CU-C	1515
Preconfigured Return (Peds Right)	PG2448ERBB	2405
Quarter-Round End-Run Bookcase (Right)	PGQBC2420-RIGHT	995
Total		\$9,585



Arc End Run-Off Desk w/ Tapered Wood Leg (Left End)	PG3060RO-ARC-TAP	\$1965
Single Storage Unit (Hinge Right)	PG2424FS	2565
Top Unit w/ Paper Management Shelf	PG1578TPM	3230
Lateral File Storage Unit	PG2436LLS	4750
<u>Modular Credenza:</u>		
Worksurface/Modesty Assembly	PG2478CA	2385
Box/Box/File Component (Ped Right)	PG18BBF	460
End Panel Component	PGSEP	240
Total		\$15,595



Step Front Reception Station (Left)	PG72RD-US	\$10800
U-Shape Configuration, Side Entry		
Floating Glass Transaction Top, rectangular	GLS-TTR	1550
Metal Center Modesty	PGRD-MTL	720
Total		\$13,070



Step Front, Bow Top Double Pedestal Desk	PG3672BB-SB	\$4030
Capitol Base Molding	CAP-BASE STEP-DBL	575
Wardrobe Storage Unit	PG2436WS	3995
Capitol Base Molding	CAP-BASE WARD	350
Preconfigured Credenza	PG2472BHDB	3320
Capitol Base Molding	CAP-BASE CREDS	475
Top Unit	PG1572T	2840
Paper Management Organizer (Left)	PG-PM05-2	535
Paper Management Organizer (Right)	PG-PM05-2	535
Gabled Top Unit Pediment	PG-GPED72	435
Lateral File Storage Unit	PG2436LFS	4365
Capitol Base Molding	CAP-BASE WARD	350
Total		\$21,805

POWER/DATA ACCESS AND WIRE MANAGEMENT

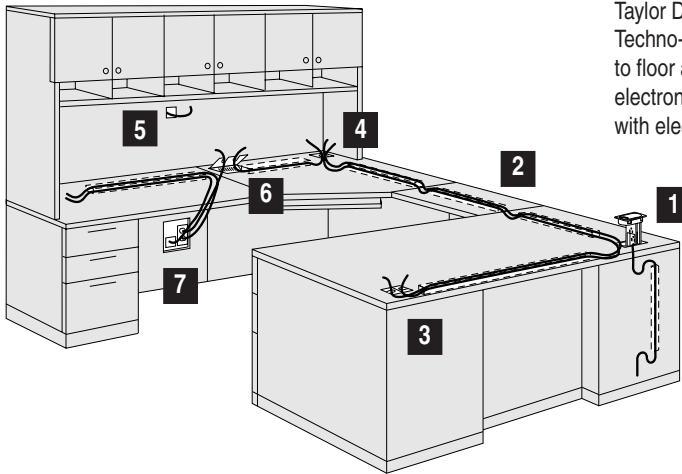

Taylor Desk offers a variety of power/data access and wire management options (see Techno-Components on page 11 for a complete listing). These components allow access to floor and wall electrical/data outlets, as well as manage wires from auxiliary lighting and electronic office equipment. NOTE: Electrical components are U.L. listed. Compliance with electrical and building codes are the sole responsibility of the customer.

1. Retractable Power/Data Center
2. Wire Management Channel
3. Double Wire Grommet
4. Single Wire Grommet
5. Single Wire Grommet (vertical)
6. Recessed Power/Data Center
7. Wire Access Panel

STANDARD GROMMET LOCATIONS

Standard grommet locations for worksurfaces and vertical modesty panels are shown below. When specifying a Wire Management Grommet, the grommet location must be included. Add the location suffix to the grommet model number (i.e., WG-1-KSC). See the grommet location key to the right. Wire management for Task Lights may be routed through the back panel of Overhead Storage Units directly behind the Task Light. To specify, add **-TLG** to the model number. Task Light wire can also be run behind Accoustical Tack Panels and through Worksurface Grommets, when specified.

Location Key:	
- L	Left
- C	Center
- R	Right
- TLG	Task Light
- KSL	Kneespace Left
- KSC	Kneespace Center
- KSR	Kneespace Right
- VML	Vertical Modesty Left
- VMR	Vertical Modesty Right

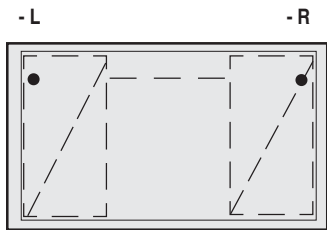

Double Pedestal Desk, Flush Top

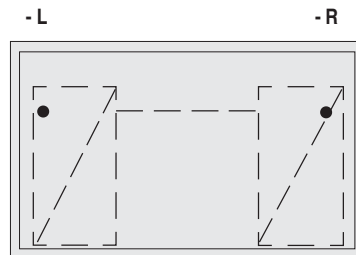

Double Pedestal Desk, Overhang Top

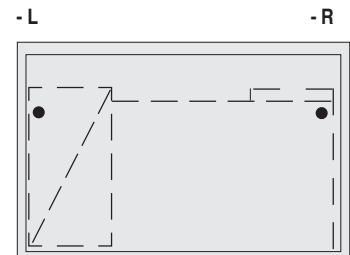

Single Pedestal Desk, Overhang Top

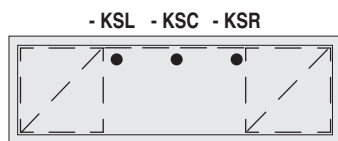

Credenza, Center Kneespace

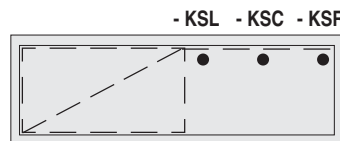

Credenza

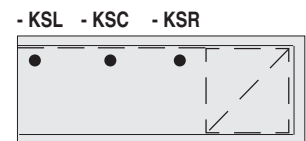

Return, plan view

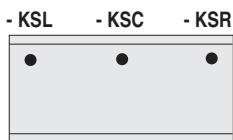

Bridge Unit

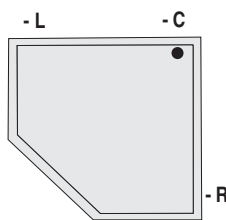

Corner Unit

Vertical Panels

Grommets may also be specified for vertical modesty panels **in open kneespaces only**. Vertical Modesty Grommets will be positioned 3" below the worksurface. To specify, add **-VML** (Vertical Modesty Left) or **-VMR** (Vertical Modesty Right) to the model number.

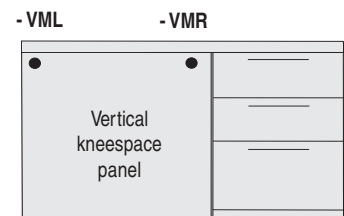

Return, elevation view

TECHNO-COMPONENTS

Model # Dimensions List Price

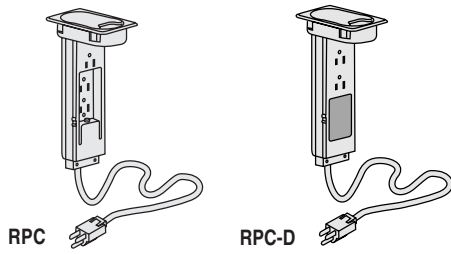

Retractable Power Center

Retractable Power Centers provide full access to electrical outlets at the worksurface by sliding up in a slotted track and then retracting to a concealed position. Centers are available in matte black and are equipped with 15 Amp circuit breaker and 6 ft. cord. U.L. and C.S.A. listed. Please submit a dimensioned drawing to specify position.

RPC	Four Electrical Outlets	\$240
RPC-D	Two Electrical Outlets and Slot for Voice and Data Modules*	220

*Taylor Desk does not supply these modules. For information on ordering modules that best meet your requirements, please contact **AMP Product Information Center at 1-800-522-6752** or **Panduit at 1-800-777-3300**.

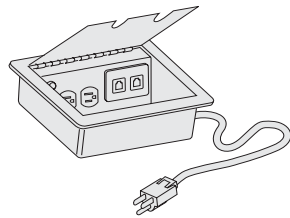

Recessed Power/Data Center

Recessed Power Centers provide full access to electrical and voice/data outlets at the worksurface. Centers are flush to the worksurface and are available in matte black. Each center is equipped with two electrical outlets, two voice/data outlets, 15 Amp circuit breaker, and 6 ft. cord. U.L. and C.S.A. listed. Please submit a dimensioned drawing to specify position.

REC-PC	4 5/8" x 8 1/8"	380
---------------	-----------------	-----

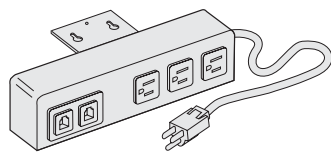

Power Strip

Power Strips provide full access to electrical and voice/data outlets beneath the worksurface for front access. Each Power Strip is equipped with three electrical outlets, two voice/data outlets, 15 Amp circuit breaker, and 6 ft. cord. U.L. and C.S.A. listed. Power Strips may be field installed. For factory installation, please submit a dimensioned drawing to specify position.

POW-STP	3" x 12" x 2 3/4" H	345
----------------	---------------------	-----

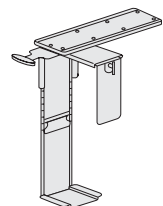

CPU Holder

CPU Holder stores the CPU vertically beneath the worksurface to protect against contaminants and saves workspace. Holder adjusts to support most CPU sizes and includes a track with 13" in/out adjustment range, 360° swivel for easy access to back panel, and an integrated handle to assist with the slide and swivel features. Matte black finish.

CPUH	17 3/4" D 3 1/4" - 8 1/2" W 13 1/2" - 24" H	375
-------------	---	-----

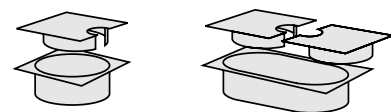

WG-1
WB-AB or WG-SN

WG-2

Wire Access Grommets are furnished with a matte black, satin nickel, or antique brass cap. Please specify grommet position, orders must be accompanied by a dimensioned drawing to insure correct locations.

WG-1	1 7/8" Diameter, Matte Black	80
WG-2	1 7/8" Diameter x 4 1/4" I.D., Matte Black	100
WG-SN	2 1/2" Diameter I.D., Satin Nickel	120
WG-AB	2 1/2" Diameter I.D., Antique Brass	120

Wire Access Grommets

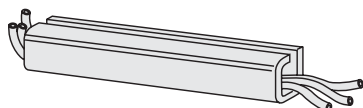

Wire Management Channel

Wire Management Channels are attached horizontally or vertically to modesty, back, or end panels below the work surface, please specify position for:

WCDP	Double Pedestal Desk or Credenza	70
WCSP	Single Pedestal Desk or Credenza	80
WCRB	Return or Bridge	60
WCCU	Corner Unit	70
WCF	48" section, trim to fit for field installation	45

WORKSPACE ACCESSORIES

Model

Dimensions

List Price

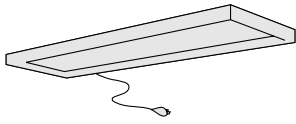

Task Light

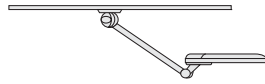

Adjustable Task Light

Task Light is mounted under overhead storage units and include 40W T12 cool white lamps with white reflector, 6 ft. cord, and center rocker switch. Black finish.

TL-27	2¾" x 7" x 27½"	\$175
TL-57	2¾" x 7" x 57½"	315

Adjustable Task Light has 18 watt CFL lamp that may be positioned anywhere along a 44" rail. Adjustable 15" long swing arm. Matte black finish.

ATL-27		415
---------------	--	-----

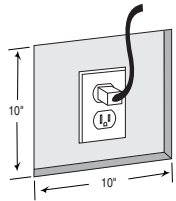

Wire Access Panel

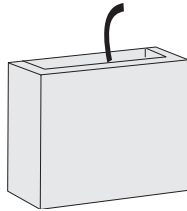

Shown Closed

Wire Access Panels provide access to wall mounted power/data outlets through a 10" x 10" opening on credenza, return, or bridge modesties/back panels. Wires can still pass through when removable door panel is in place. Standard position is centered (left-to-right) in any open knee-space, while the bottom of the Wire Access Panel is 10" to the floor. To specify non-standard positions, orders must be accompanied by a dimensioned drawing.

WAP-M	10" x 10" H	215
--------------	-------------	-----

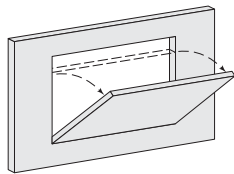

Hinged Modesty for Wire Access

A hinged modesty panel allows wall access and may be specified for returns, bridges, or credenza knee-space areas 32" wide or longer. A wire management cut-out is provided with all hinged modesties.

HM	18" x 26"	240
-----------	-----------	-----

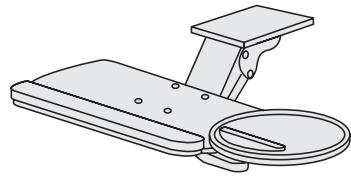

Articulating Keyboard Tray with Articulating Mousepad

Articulating Keyboard Tray with Articulating Mousepad is mounted below the worksurface and adjusts from worksurface level to 6" below, 15° tilt and 360° rotations. Fully retractable to store with a minimum intrusion to knee-space. All adjustments lock to position. Swivel/tilting mousepad may be mounted on the right or left side. Both tray and mousepad include gel wrist rests. Matte black finish.

AK-MP2	Tray: 10¼" x 20" Mousepad: 9"W x 7½"D	470
---------------	--	-----

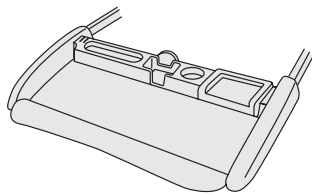

Pull-Out Keyboard Tray with Mousepad

Pull-Out Keyboard Tray with Mousepad. Tray tilts -7°, -3.5°, and neutral. Locks into three positions. Fully retractable to store with a minimum intrusion to knee-space. Tray includes gel wrist rest and several storage compartments for supplies. Mousepad may be positioned on the right or left side. Matte black finish.

PK2	9¼" x 25½" includes mousepad	395
------------	---------------------------------	-----

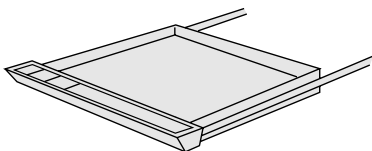

Center Drawer

Center Drawer is mounted below the worksurface of Double or Single Pedestal Desks, Table, Conferencing, or Run-Off Desks. Solid Maple drawer front, as well as storage compartments for supplies are included.

CD		250
-----------	--	-----

WORKSPACE ACCESSORIES

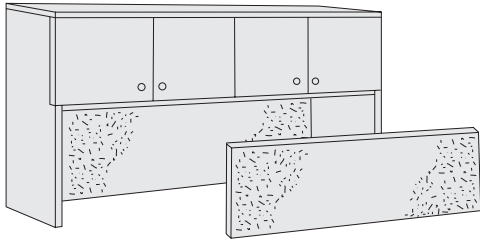

Fabric covered Acoustical Tack Panels are available for Top Units or for Wall Mount applications. Panels are covered with **Maharam Messenger (pattern #458640) Balsa (color #001)**. COM may also be specified, see fabric requirements listed below. Yardage requirements are based on 54" wide fabric. COM fabrics should be shipped to: **Taylor Desk 11020 Santa Fe Avenue, Lynwood, CA 90262** and clearly side marked with the customer name and purchase order number. Taylor Desk is not responsible for shipping errors made by the fabric company. Please indicate on your purchase order: the COM fabric company name, pattern name and number, and color name and number. To receive a memo sample of Messenger Balsa, please contact Maharam directly at **1.800.645.3943**. NOTE: For wall mount applications, specify **-WM** after the tack panel model number.

maharam

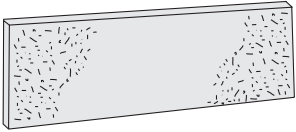
	Model #	Dimensions	Yardage Required	COM List Price	Messenger Balsa List Price
 Acoustical Tack Panel	TP-36	36"W	1¼ yds.	\$295	\$355
	TP-72	72"W	2¼ yds.	360	465
	TP-78	78"W	2½ yds.	370	485
	TP-84	84"W	2½ yds.	380	500
	TP-92	92"W	2¾ yds.	395	520
	TP-96	96"W	3 yds.	400	540
	TP-102	102"W	3¼ yds.	405	560
	TP-108	108"W (2 pieces)	3½ yds.	420	585

Accessory Wall for Credenza Top Units. May be used in combination with Acoustical Fabric Tack Panel. Accessory Walls consist of an extruded, black, plastic slatwall. When used in conjunction with Organizing Elements, Accessory Walls provide added workspace through paper management and easy-to-access storage for desktop items.

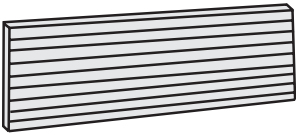
 Accessory Wall	ACC-AW36	36"W x 16½"H	290
	ACC-AW72	72"W x 16½"H	360
	ACC-AW78	78"W x 16½"H	385
	ACC-AW84	84"W x 16½"H	395
	ACC-AW92	92"W x 16½"H	420
	ACC-AW96	96"W x 16½"H	430
	ACC-AW102	102"W x 16½"H	455
	ACC-AW108	108"W x 16½"H	465

Organizing Elements to be used with Accessory Wall. Organizing Elements are molded, black plastic with a textured finish. Elements hang on Accessory Wall and may be repositioned at any time without the use of tools.

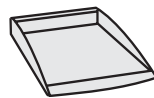

ACC-PT
Paper Tray
9½"W x 2"H x 14"L
\$40

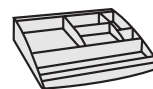

ACC-AT
Accessory Tray
9½"W x 2"H x 10"L
\$30



ACC-FT
Folder Tray
7"W x 2½"H x 12½"L
\$45



ACC-BH
Binder Holder
5"W x 9"H x 10½"L
\$25



ACC-PC
Pencil Cup
4"W x 4"H x 3½"L
\$15



ACC-PS
Phone Support
8½"W x 2"H x 9½"L
\$30



ACC-CDH
CD Holder
5½"W x 2"H x 7"L
\$25

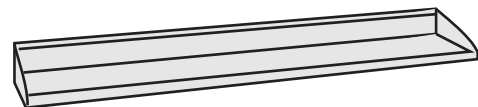

ACC-S24 Shelf 7"W x 2"H x 24"L \$95
ACC-S30 Shelf 7"W x 2"H x 30"L \$110
ACC-S36 Shelf 7"W x 2"H x 36"L \$130

DESKS

Paull Group offers three desk styles: Recessed Front, Flush Front, and Step Front, as well as two top shapes, rectangle and bow (available on Flush and Step only). Tops are shaped into one of eleven edge details and hardware is standard on all desks (see pages 5-6 for a complete description of edges and hardware). For further flexibility, there are six modesty options to choose from for Step Front Desks (see page 16).

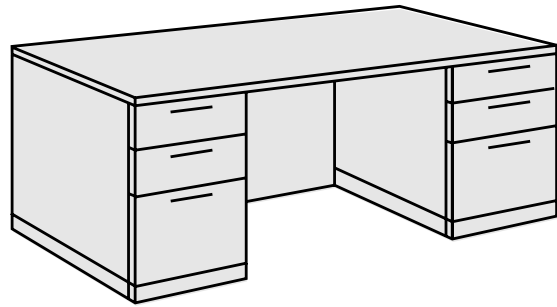

A wide selection of Table Desks and Conferencing Desks are also offered in Paull Group. Table Desks tops are available in four top shapes: Arc End, Bow Top, Rectangle, and Round, as well as three leg styles: tapered wood with metal trim, flaired metal, and black metal column. All desks styles will accept center drawers and wire management grommets and channels (see pages 10-12 for a complete description and pricing).

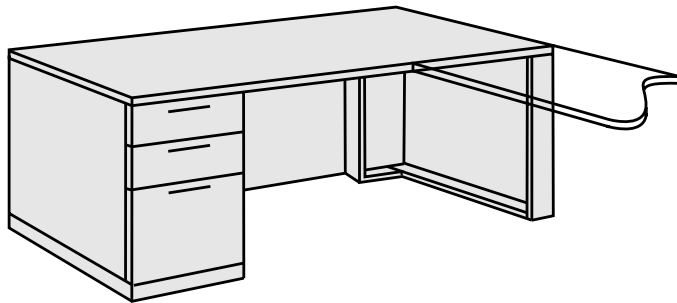

Double or Single Pedestal Desks are available in several sizes and offered in Box|Box|File or File|File combinations. Pedestals are legal width (except pedestals on 60" wide desks, which are letter width) and are standard with locks in the kneespace. Single Pedestal Desks are reconfigurable in the field where the pedestal can be switched from right to left to accommodate changing needs.

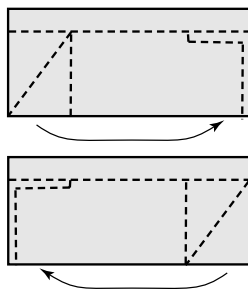

Recessed Front, Double Pedestal Desk

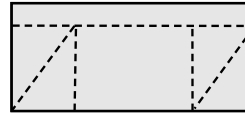
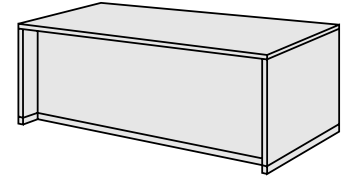

Flush Front, Double Pedestal Desk

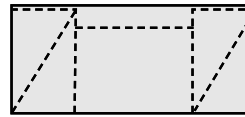
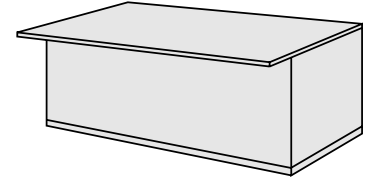

Step Front, Double Pedestal Desk

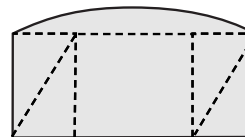
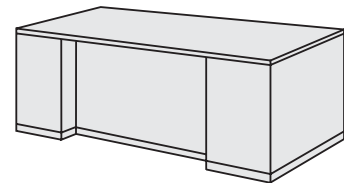

Flush Front, Bow Top, Double Pedestal Desk

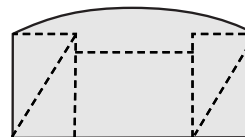
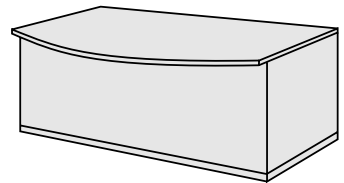

Step Front, Bow Top, Double Pedestal Desk

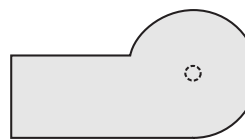
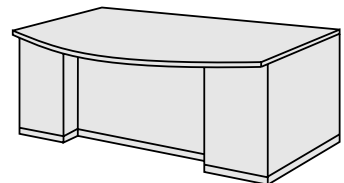

P-Top Conferencing Desk

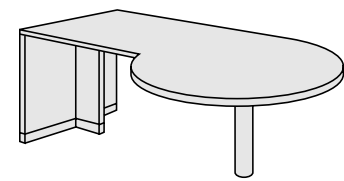

Arc End Table Desk with Tapered Wood Leg and Metal Trim

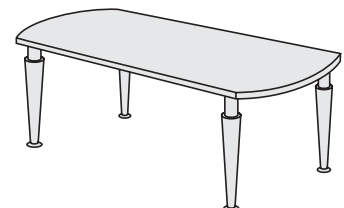

DESKS - CONFERRING AND RUN-OFF

Paull Group's Conferencing and Run-Off Desks provide an alternative to the standard single or double pedestal desk. With several top shapes and leg styles to choose from, as well as a selection modesty panels (see page 16), Conferencing and Run-Off Desks can be incorporated into a variety of office environments.

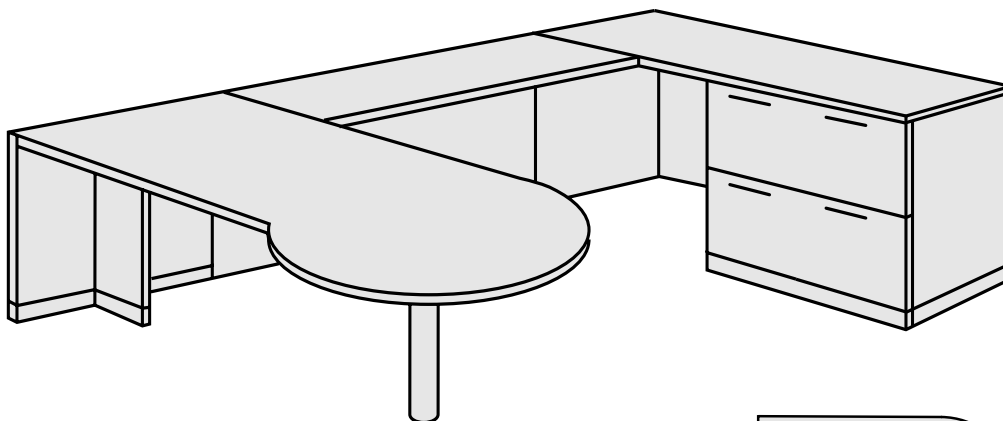
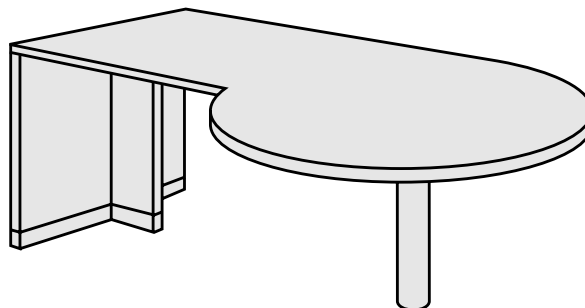

Conferencing Desks are free-standing units supported by an end panel and leg and designed to accept any return or bridge unit. Conferencing Desks must be specified from right or left from user side. Run-Off Desks must attach to the kneespace of a credenza and be specified as a right or left extension from the credenza. All the necessary hardware for attachment is included for both Conferencing and Run-Off Desks. An optional center drawer may be added to any style, see page 12 for a complete description and pricing.



Bullet

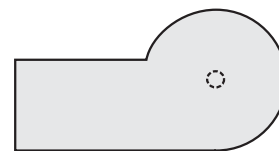

P-Top



Arc End

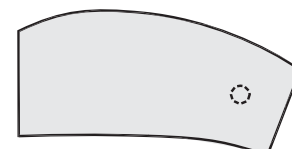

Sailfin

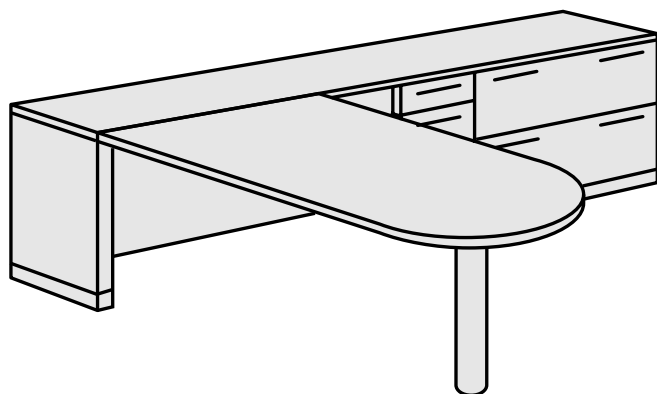

Four top shapes are available with Paull Group Conferencing and Run-Off Desks: Bullet, Arc End, P-Top, and Sailfin. Bullet and Arc End Desks are non-handed, allowing the flexibility for left and right configurations, while P-Top and Sailfin Desks are handed.

Conferencing and Run-Off Desks offer three leg styles: tapered wood leg with metal trim, wood column, and black metal column. Both the tapered wood leg and wood column leg are finished to match the desk top.



Tapered Wood Leg
with Metal Trim



Wood Column Leg
(6" diameter)



Black Metal Column Leg
(6" diameter)

MODESTY PANELS

Step Front Desks and Reception Stations can be punctuated with one of six modesty panel options. The standard modesty is a full panel consisting of Maple veneer laid up onto substrate by Taylor Desk craftsmen. Optional modesty panels include: Perforated Metal, Full Metal, Open Metal, Perforated Wood, Arched Wood, and Open Wood.

The Perforated Metal Modesty consists of an anodized aluminum surfaced panel with a stainless brush finish. The distinct perforation pattern creates a different look to the metal panel, as well as the wood panel. The Arched Modesty has a subtle curve cut out from the base of a full panel.

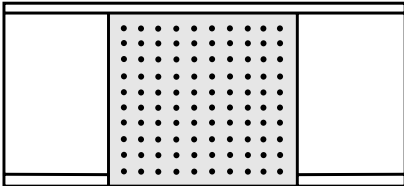
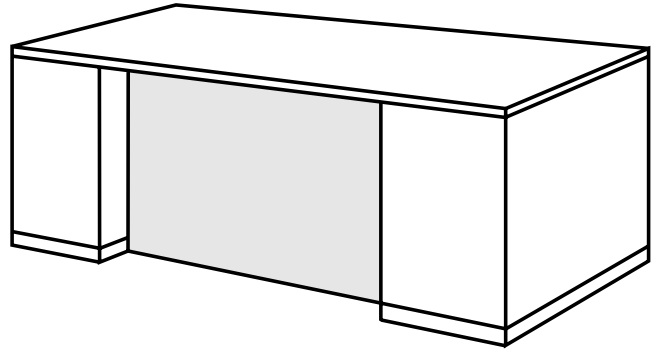

Perforated Wood
Center Modesty Panel on Step Front Desks and Reception Desks, Conferencing Desks

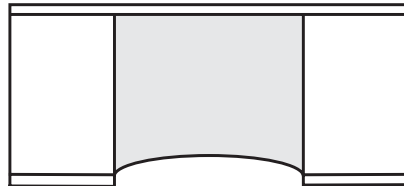

Arched Wood
Center Modesty Panel on Step Front Desks

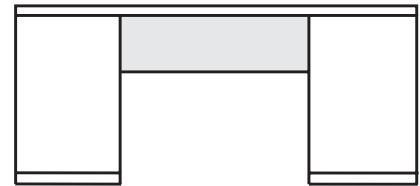

Open Wood
Center Modesty Panel on Step Front Desks

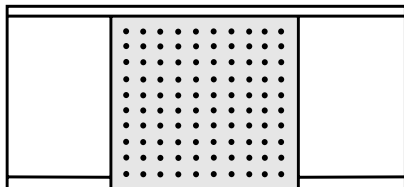

Perforated Metal
Center Modesty Panel on Step Front Desks and Reception Desks, Conferencing Desks



Full Metal
Center Modesty Panel on Step Front Desks and Reception Desks, Conferencing Desks

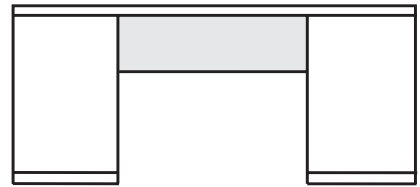

Open Metal
Center Modesty Panel on Step Front Desks

Closed Modesty Panels can also be used on free-standing Conferencing Desks that are specified with a Wood or Black Metal Column Leg. Modesties available are: Wood, Perforated Wood, and Perforated Metal. Closed Modesties are not available on those Conferencing Desks that incorporate a Tapered Wood Leg with Metal Trim.

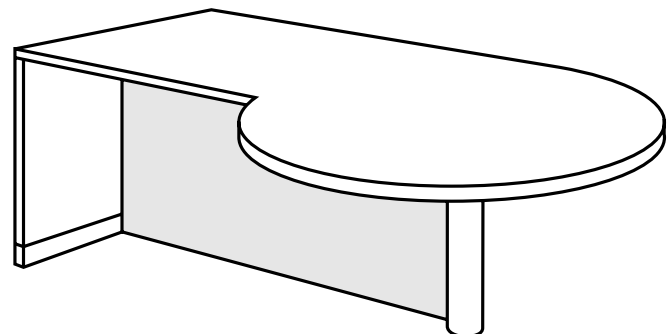

DESKS - RECESSED FRONT

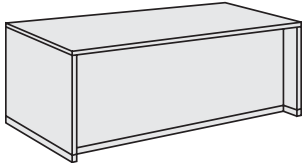

To specify, include:

- Model Number
- Wood Finish
- Edge Detail
- Hardware Style
- Hardware Finish

Wood Finishes	Edge Details	Hardware Style	Available Options	List Price
<ul style="list-style-type: none"> • CML Clear Maple • COL Clear Oak on Maple • AMB Amber on Maple • CHY Cherry on Maple • RCL Royal Cherry on Maple • LWL Light Walnut on Maple • ESP Espresso on Maple • MHL Mahogany on Maple • SMK Smoke on Maple 	(see p. 5) <ul style="list-style-type: none"> • AR Arc • BV Bevel • CL Classic • CV Cove • EL Ellipse • FL Fluted • RD Radius • RE Reveal • SQ Square • TD Traditional • TR Transitional 	(see p. 6 for finishes) <ul style="list-style-type: none"> • AR Arc • CU Cube • HE Heritage • OR Orbit • SW Swoop • TA Tab • FP Side-Routed Finger Pull 	<ul style="list-style-type: none"> • CD Center Drawer • AK-MP2 Articulating Keyboard Tray • PK2 Pull-Out Keyboard Tray • WG-1 Matte Black Grommet - 1 7/8" diameter I.D. • WG-2 Matte Black Grommet - 1 7/8" diameter x 4 1/4" I.D. • WG-AB Antique Brass Grommet - 2 1/2" diameter I.D. • WG-SN Satin Nickel Grommet - 2 1/2" diameter I.D. (see page 10 for location information) (see page 11-13 for additional accessories)	<ul style="list-style-type: none"> \$250 470 395 80 100 120 120

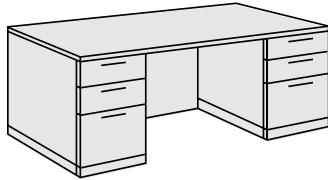

Double Pedestal Desk, Recessed Front

	Model #	Dimensions	List Price
• 2 1/4" recessed front on 30"D desks	PG3060BB-R	30" x 60" x 29"H	\$3245
• 8 1/4" recessed front on 36"D desks	PG3666BB-R	36" x 66" x 29"H	3355
• Legal width pedestals	PG3072BB-R	30" x 72" x 29"H	3355
• Letter width pedestals for 60" desk	PG3672BB-R	36" x 72" x 29"H	3460
• Box Box File drawers on each pedestal	PG3684BB-R	36" x 84" x 29"H	3660
• Pedestal locks included			
• Optional center drawer			

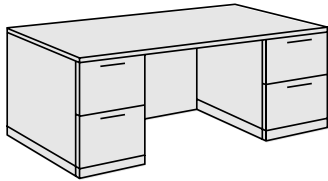

Double Pedestal Desk, Recessed Front

• 2 1/4" recessed front on 30"D desks	PG3060FF-R	30" x 60" x 29"H	3245
• 8 1/4" recessed front on 36"D desks	PG3666FF-R	36" x 66" x 29"H	3355
• Legal width pedestals	PG3072FF-R	30" x 72" x 29"H	3355
• Letter width pedestals for 60" desk	PG3672FF-R	36" x 72" x 29"H	3460
• File File drawers on each pedestal	PG3684FF-R	36" x 84" x 29"H	3660
• Pedestal locks included			
• Optional center drawer			

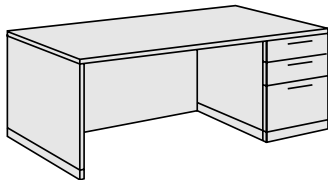

Single Pedestal Desk, Recessed Front

• 2 1/4" recessed front on 30"D desks	PG3060SPB-R	30" x 60" x 29"H	2980
• 8 1/4" recessed front on 36"D desks	PG3666SPB-R	36" x 66" x 29"H	3090
• Legal width pedestal	PG3072SPB-R	30" x 72" x 29"H	3090
• Letter width pedestal for 60" desk	PG3672SPB-R	36" x 72" x 29"H	3195
• Box Box File drawers on pedestal	PG3684SPB-R	36" x 84" x 29"H	3395
• Pedestal lock included			
• Optional center drawer			
• Necessary hardware for attachment included			
• Must specify left or right pedestal sitting from user side			

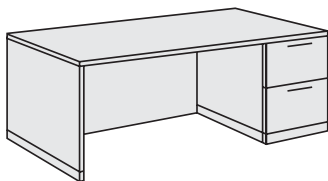

Single Pedestal Desk, Recessed Front

• 2 1/4" recessed front on 30"D desks	PG3060SPF-R	30" x 60" x 29"H	2980
• 8 1/4" recessed front on 36"D desks	PG3666SPF-R	36" x 66" x 29"H	3090
• Legal width pedestal	PG3072SPF-R	30" x 72" x 29"H	3090
• Letter width pedestal for 60" desk	PG3672SPF-R	36" x 72" x 29"H	3195
• File File drawers on pedestal	PG3684SPF-R	36" x 84" x 29"H	3395
• Pedestal lock included			
• Optional center drawer			
• Necessary hardware for attachment included			
• Must specify left or right pedestal sitting from user side			

DESKS - FLUSH FRONT

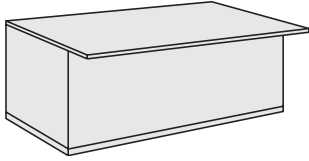

To specify, include:

- Model Number
- Wood Finish
- Edge Detail
- Hardware Style
- Hardware Finish

Wood Finishes	Edge Details	Hardware Style	Available Options	List Price
<ul style="list-style-type: none"> • CML Clear Maple • COL Clear Oak on Maple • AMB Amber on Maple • CHY Cherry on Maple • RCL Royal Cherry on Maple • LWL Light Walnut on Maple • ESP Espresso on Maple • MHL Mahogany on Maple • SMK Smoke on Maple 	(see p. 5) <ul style="list-style-type: none"> • AR Arc • BV Bevel • CL Classic • CV Cove • EL Ellipse • FL Fluted • RD Radius • RE Reveal • SQ Square • TD Traditional • TR Transitional 	(see p. 6 for finishes) <ul style="list-style-type: none"> • AR Arc • CU Cube • HE Heritage • OR Orbit • SW Swoop • TA Tab • FP Side-Routed Finger Pull 	<ul style="list-style-type: none"> • CD Center Drawer • AK-MP2 Articulating Keyboard Tray • PK2 Pull-Out Keyboard Tray • WG-1 Matte Black Grommet - 1 7/8" diameter I.D. • WG-2 Matte Black Grommet - 1 7/8" diameter x 4 1/4" I.D. • WG-AB Antique Brass Grommet - 2 1/2" diameter I.D. • WG-SN Satin Nickel Grommet - 2 1/2" diameter I.D. (see page 10 for location information) (see page 11-13 for additional accessories)	<ul style="list-style-type: none"> \$250 470 395 80 100 120 120

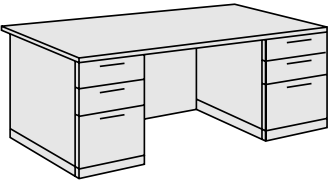

Double Pedestal Desk, Flush Front

- 2 1/4" front overhang on 30"D desks
- 8 1/4" front overhang on 36"D desks
- Legal width pedestals
- Letter width pedestals for 60" desk
- Box|Box|File drawers on each pedestal
- Pedestal locks included
- Optional center drawer

Model #	Dimensions	List Price
---------	------------	------------

PG3060BB-F	30" x 60" x 29"H	\$3005
PG3666BB-F	36" x 66" x 29"H	3115
PG3072BB-F	30" x 72" x 29"H	3115
PG3672BB-F	36" x 72" x 29"H	3225
PG3684BB-F	36" x 84" x 29"H	3425

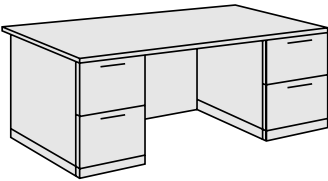

Double Pedestal Desk, Flush Front

- 2 1/4" front overhang on 30"D desks
- 8 1/4" front overhang on 36"D desks
- Legal width pedestals
- Letter width pedestals for 60" desk
- File|File drawers on each pedestal
- Pedestal locks included
- Optional center drawer

PG3060FF-F	30" x 60" x 29"H	3005
PG3666FF-F	36" x 66" x 29"H	3115
PG3072FF-F	30" x 72" x 29"H	3115
PG3672FF-F	36" x 72" x 29"H	3225
PG3684FF-F	36" x 84" x 29"H	3425

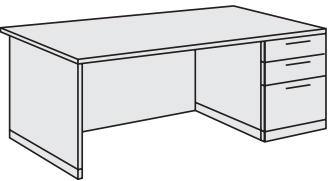

Single Pedestal Desk, Flush Front

- 2 1/4" front overhang on 30"D desks
- 8 1/4" front overhang on 36"D desks
- Legal width pedestal
- Letter width pedestal for 60" desk
- Box|Box|File drawers on pedestal
- Pedestal lock included
- Optional center drawer
- Necessary hardware for attachment included
- **Must specify left or right pedestal sitting from user side**

PG3060SPB-F	30" x 60" x 29"H	2720
PG3666SPB-F	36" x 66" x 29"H	2830
PG3072SPB-F	30" x 72" x 29"H	2830
PG3672SPB-F	36" x 72" x 29"H	2940
PG3684SPB-F	36" x 84" x 29"H	3140

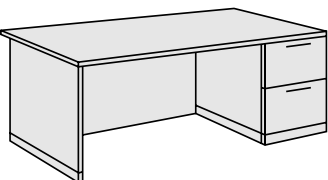

Single Pedestal Desk, Flush Front

- 2 1/4" front overhang on 30"D desks
- 8 1/4" front overhang on 36"D desks
- Legal width pedestal
- Letter width pedestal for 60" desk
- File|File drawers on pedestal
- Pedestal lock included
- Optional center drawer
- Necessary hardware for attachment included
- **Must specify left or right pedestal sitting from user side**

PG3060SPF-F	30" x 60" x 29"H	2720
PG3666SPF-F	36" x 66" x 29"H	2830
PG3072SPF-F	30" x 72" x 29"H	2830
PG3672SPF-F	36" x 72" x 29"H	2940
PG3684SPF-F	36" x 84" x 29"H	3140

DESKS - FLUSH FRONT WITH BOW TOP

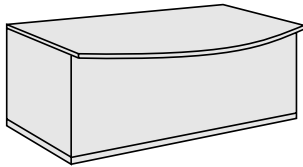

To specify, include:

- Model Number
- Wood Finish
- Edge Detail
- Hardware Style
- Hardware Finish

Wood Finishes

- **CML** Clear Maple
- **COL** Clear Oak on Maple
- **AMB** Amber on Maple
- **CHY** Cherry on Maple
- **RCL** Royal Cherry on Maple
- **LWL** Light Walnut on Maple
- **ESP** Espresso on Maple
- **MHL** Mahogany on Maple
- **SMK** Smoke on Maple

Edge Details
(see p. 5)

- **AR** Arc
- **BV** Bevel
- **CL** Classic
- **CV** Cove
- **EL** Ellipse
- **FL** Fluted
- **RD** Radius
- **RE** Reveal
- **SQ** Square
- **TD** Traditional
- **TR** Transitional

Hardware Style
(see p. 6 for finishes)

- **AR** Arc
- **CU** Cube
- **HE** Heritage
- **OR** Orbit
- **SW** Swoop
- **TA** Tab
- **FP** Side-Routed Finger Pull

Available Options

- **CD** Center Drawer **\$250**
- **AK-MP2** Articulating Keyboard Tray **470**
- **PK2** Pull-Out Keyboard Tray **395**
- **WG-1** Matte Black Grommet - 1 7/8" diameter I.D. **80**
- **WG-2** Matte Black Grommet - 1 7/8" diameter x 4 1/4" I.D. **100**
- **WG-AB** Antique Brass Grommet - 2 1/2" diameter I.D. **120**
- **WG-SN** Satin Nickel Grommet - 2 1/2" diameter I.D. **120**
(see page 10 for location information)
(see page 11-13 for additional accessories)

List Price

	Model #	Dimensions	List Price
--	----------------	-------------------	-------------------

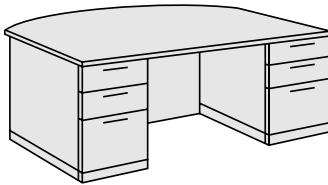

- 10 1/4" front overhang at deepest point
- Legal width pedestals
- Letter width pedestals for 60" desk
- Box|Box|File drawers on each pedestal
- Pedestal locks included
- Optional center drawer

PG3666BB-FB	32" to 38" x 66" x 29"H	\$3375
PG3672BB-FB	32" to 38" x 72" x 29"H	3520
PG3684BB-FB	32" to 38" x 84" x 29"H	3770

Double Pedestal Desk, Flush Front, Bow Top

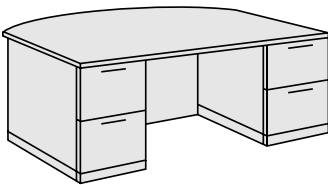

- 10 1/4" front overhang at deepest point
- Legal width pedestals
- Letter width pedestals for 60" desk
- File|File drawers on each pedestal
- Pedestal locks included
- Optional center drawer

PG3666FF-FB	32" to 38" x 66" x 29"H	3375
PG3672FF-FB	32" to 38" x 72" x 29"H	3520
PG3684FF-FB	32" to 38" x 84" x 29"H	3770

Double Pedestal Desk, Flush Front, Bow Top

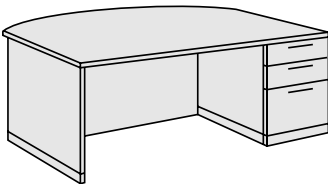

- 10 1/4" front overhang at deepest point
- Legal width pedestal
- Letter width pedestal for 60" desk
- Box|Box|File drawers on pedestal
- Pedestal lock included
- Optional center drawer
- Necessary hardware for attachment included
- **Must specify left or right pedestal sitting from user side**

PG3666SPB-FB	32" to 38" x 66" x 29"H	3090
PG3672SPB-FB	32" to 38" x 72" x 29"H	3195
PG3684SPB-FB	32" to 38" x 84" x 29"H	3420

Single Pedestal Desk, Flush Front, Bow Top

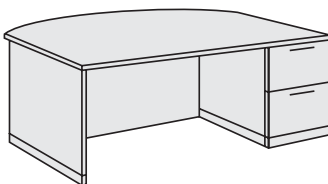

- 10 1/4" front overhang at deepest point
- Legal width pedestal
- Letter width pedestal for 60" desk
- File|File drawers on pedestal
- Pedestal lock included
- Optional center drawer
- Necessary hardware for attachment included
- **Must specify left or right pedestal sitting from user side**

PG3666SPF-FB	32" to 38" x 66" x 29"H	3090
PG3672SPF-FB	32" to 38" x 72" x 29"H	3195
PG3684SPF-FB	32" to 38" x 84" x 29"H	3420

Single Pedestal Desk, Flush Front, Bow Top

DESKS - STEP FRONT

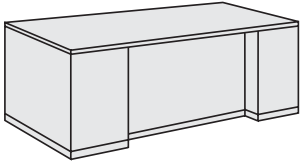

To specify, include:

- Model Number
- Wood Finish
- Edge Detail
- Hardware Style
- Hardware Finish

Wood Finishes	Edge Details (see p. 5)	Hardware Style (see p. 6 for finishes)	Available Options	List Price
<ul style="list-style-type: none"> • CML Clear Maple • COL Clear Oak on Maple • AMB Amber on Maple • CHY Cherry on Maple • RCL Royal Cherry on Maple • LWL Light Walnut on Maple • ESP Espresso on Maple • MHL Mahogany on Maple • SMK Smoke on Maple 	<ul style="list-style-type: none"> • AR Arc • BV Bevel • CL Classic • CV Cove • EL Ellipse • FL Fluted • RD Radius • RE Reveal • SQ Square • TD Traditional • TR Transitional 	<ul style="list-style-type: none"> • AR Arc • CU Cube • HE Heritage • OR Orbit • SW Swoop • TA Tab • FP Side-Routed Finger Pull 	<ul style="list-style-type: none"> • CD Center Drawer \$250 • PGMOD Modesty Options -PERFWD Perforated Wood Modesty 500 -ARC Arched Wood Modesty 295 -OPWD Open Wood Modesty 205 -PERFML Perforated Metal Modesty 595 -FLMTL Full Metal Modesty 510 -OPMTL Open Metal Modesty 295 • WG-1 Matte Black Grommet - 1 7/8" diameter I.D. 80 • WG-2 Matte Black Grommet - 1 7/8" diameter x 4 1/4" I.D. 100 (see page 10 for location information) (see page 11-13 for additional accessories) 	

	Model #	Dimensions	List Price
--	---------	------------	------------

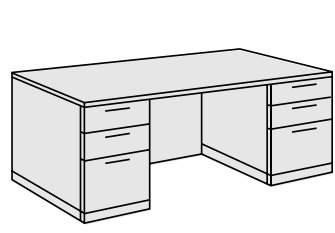

- Legal width pedestals
- Letter width pedestals for 60" desk
- Box|Box|File drawers on each pedestal
- Pedestal locks included
- Optional center drawer
- Center modesty options

PG3060BB-S	30" x 60" x 29"H	\$3570
PG3666BB-S	36" x 66" x 29"H	3680
PG3072BB-S	30" x 72" x 29"H	3680
PG3672BB-S	36" x 72" x 29"H	3790
PG3684BB-S	36" x 84" x 29"H	3990

Double Pedestal Desk, Step Front

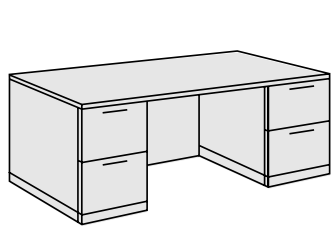

- Legal width pedestals
- Letter width pedestals for 60" desk
- File|File drawers on each pedestal
- Pedestal locks included
- Optional center drawer
- Center modesty options

PG3060FF-S	30" x 60" x 29"H	3570
PG3666FF-S	36" x 66" x 29"H	3680
PG3072FF-S	30" x 72" x 29"H	3680
PG3672FF-S	36" x 72" x 29"H	3790
PG3684FF-S	36" x 84" x 29"H	3990

Double Pedestal Desk, Step Front

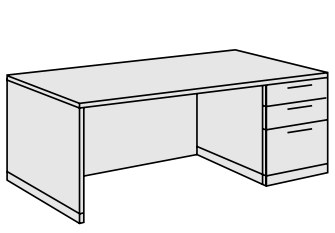

- Legal width pedestal
- Letter width pedestal for 60" desk
- Box|Box|File drawers on pedestal
- Pedestal lock included
- Optional center drawer
- Center modesty options
- Necessary hardware for attachment included
- **Must specify left or right pedestal sitting from user side**

PG3060SPB-S	30" x 60" x 29"H	3310
PG3666SPB-S	36" x 66" x 29"H	3420
PG3072SPB-S	30" x 72" x 29"H	3420
PG3672SPB-S	36" x 72" x 29"H	3530
PG3684SPB-S	36" x 84" x 29"H	3730

Single Pedestal Desk, Step Front

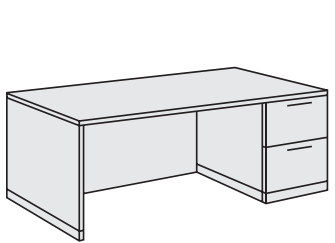

- Legal width pedestal
- Letter width pedestal for 60" desk
- File|File drawers on pedestal
- Pedestal lock included
- Optional center drawer
- Center modesty options
- Necessary hardware for attachment included
- **Must specify left or right pedestal sitting from user side**

PG3060SPF-S	30" x 60" x 29"H	3310
PG3666SPF-S	36" x 66" x 29"H	3420
PG3072SPF-S	30" x 72" x 29"H	3420
PG3672SPF-S	36" x 72" x 29"H	3530
PG3684SPF-S	36" x 84" x 29"H	3730

Single Pedestal Desk, Step Front

DESKS - STEP FRONT WITH OVERHANG TOP

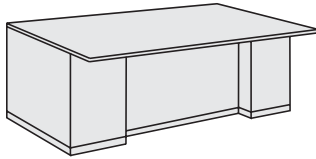

To specify, include:

- Model Number
- Wood Finish
- Edge Detail
- Hardware Style
- Hardware Finish

Wood Finishes

- **CML** Clear Maple
- **COL** Clear Oak on Maple
- **AMB** Amber on Maple
- **CHY** Cherry on Maple
- **RCL** Royal Cherry on Maple
- **LWL** Light Walnut on Maple
- **ESP** Espresso on Maple
- **MHL** Mahogany on Maple
- **SMK** Smoke on Maple

Edge Details
(see p. 5)

- **AR** Arc
- **BV** Bevel
- **CL** Classic
- **CV** Cove
- **EL** Ellipse
- **FL** Fluted
- **RD** Radius
- **RE** Reveal
- **SQ** Square
- **TD** Traditional
- **TR** Transitional

Hardware Style
(see p. 6 for finishes)

- **AR** Arc
- **CU** Cube
- **HE** Heritage
- **OR** Orbit
- **SW** Swoop
- **TA** Tab
- **FP** Side-Routed Finger Pull

Available Options

- **CD** Center Drawer **\$250**
- **PGMOD** **Modesty Options**
- **-PERFWD** Perforated Wood Modesty **500**
- **-ARC** Arched Wood Modesty **295**
- **-OPWD** Open Wood Modesty **205**
- **-PERFML** Perforated Metal Modesty **595**
- **-FLMTL** Full Metal Modesty **510**
- **-OPMTL** Open Metal Modesty **295**
- **WG-1** Matte Black Grommet - 1 7/8" diameter I.D. **80**
- **WG-2** Matte Black Grommet - 1 7/8" diameter x 4 1/4" I.D. **100**
(see page 10 for location information)
(see page 11-13 for additional accessories)

	Model #	Dimensions	List Price
--	---------	------------	------------

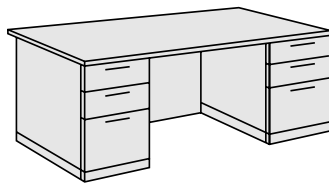

- 8¼-11¼" front overhang
- Legal width pedestals
- Letter width pedestals for 60" desk
- Box|Box|File drawers on each pedestal
- Pedestal locks included
- Optional center drawer
- Center modesty options

PG3666BB-SO	36" x 66" x 29"H	\$3680
PG3672BB-SO	36" x 72" x 29"H	3790
PG3684BB-SO	36" x 84" x 29"H	3990

Double Pedestal Desk, Step Front, Overhang Top

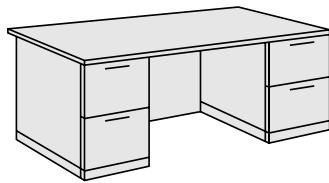

- 8¼-11¼" front overhang
- Legal width pedestals
- Letter width pedestals for 60" desk
- File|File drawers on each pedestal
- Pedestal locks included
- Optional center drawer
- Center modesty options

PG3666FF-SO	36" x 66" x 29"H	3680
PG3672FF-SO	36" x 72" x 29"H	3790
PG3684FF-SO	36" x 84" x 29"H	3990

Double Pedestal Desk, Step Front, Overhang Top

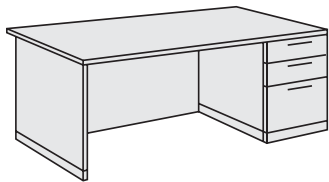

- 8¼-11¼" front overhang
- Legal width pedestal
- Letter width pedestal for 60" desk
- Box|Box|File drawers on pedestal
- Pedestal locks included
- Optional center drawer
- Center modesty options
- Necessary hardware for attachment included
- **Must specify left or right pedestal sitting from user side**

PG3666SPB-SO	36" x 66" x 29"H	3420
PG3672SPB-SO	36" x 72" x 29"H	3530
PG3684SPB-SO	36" x 84" x 29"H	3730

Single Pedestal Desk, Step Front, Overhang Top

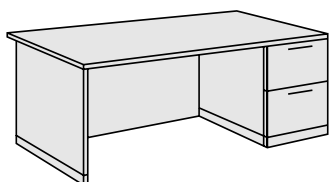

- 8¼-11¼" front overhang
- Legal width pedestal
- Letter width pedestal for 60" desk
- File|File drawers on pedestal
- Pedestal locks included
- Optional center drawer
- Center modesty options
- Necessary hardware for attachment included
- **Must specify left or right pedestal sitting from user side**

PG3666SPF-SO	36" x 66" x 29"H	3420
PG3672SPF-SO	36" x 72" x 29"H	3530
PG3684SPF-SO	36" x 84" x 29"H	3730

Single Pedestal Desk, Step Front, Overhang Top

DESKS - STEP FRONT WITH BOW TOP

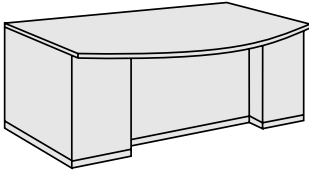

To specify, include:

- Model Number
- Wood Finish
- Edge Detail
- Hardware Style
- Hardware Finish

Wood Finishes

- **CML** Clear Maple
- **COL** Clear Oak on Maple
- **AMB** Amber on Maple
- **CHY** Cherry on Maple
- **RCL** Royal Cherry on Maple
- **LWL** Light Walnut on Maple
- **ESP** Espresso on Maple
- **MHL** Mahogany on Maple
- **SMK** Smoke on Maple

Edge Details

- (see p. 5)
- **AR** Arc
 - **BV** Bevel
 - **CL** Classic
 - **CV** Cove
 - **EL** Ellipse
 - **FL** Fluted
 - **RD** Radius
 - **RE** Reveal
 - **SQ** Square
 - **TD** Traditional
 - **TR** Transitional

Hardware Style

- (see p. 6 for finishes)
- **AR** Arc
 - **CU** Cube
 - **HE** Heritage
 - **OR** Orbit
 - **SW** Swoop
 - **TA** Tab
 - **FP** Side-Routed Finger Pull

Available Options

- **CD** Center Drawer **\$250**
 - **PGMOD** **Modesty Options**
 - **-PERFWD** Perforated Wood Modesty **500**
 - **-ARC** Arched Wood Modesty **295**
 - **-OPWD** Open Wood Modesty **205**
 - **-PERFML** Perforated Metal Modesty **595**
 - **-FLMTL** Full Metal Modesty **510**
 - **-OPMTL** Open Metal Modesty **295**
 - **WG-1** Matte Black Grommet - 1 7/8" diameter I.D. **80**
 - **WG-2** Matte Black Grommet - 1 7/8" diameter x 4 1/4" I.D. **100**
- (see page 10 for location information)
(see page 11-13 for additional accessories)

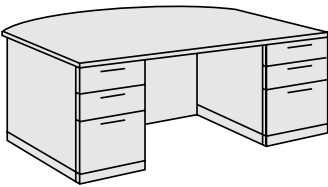

Double Pedestal Desk, Step Front, Bow Top

- Legal width pedestals
- Letter width pedestals for 60" desk
- Box|Box|File drawers on each pedestal
- Pedestal locks included
- Optional center drawer
- Center modesty options

Model #	Dimensions	List Price
PG3666BB-SB	32" to 38" x 66" x 29"H	\$3920
PG3672BB-SB	32" to 38" x 72" x 29"H	4030
PG3684BB-SB	32" to 38" x 84" x 29"H	4245

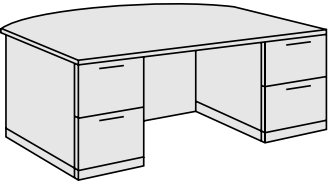

Double Pedestal Desk, Step Front, Bow Top

- Legal width pedestals
- Letter width pedestals for 60" desk
- File|File drawers on each pedestal
- Pedestal locks included
- Optional center drawer
- Center modesty options

PG3666FF-SB	32" to 38" x 66" x 29"H	3920
PG3672FF-SB	32" to 38" x 72" x 29"H	4030
PG3684FF-SB	32" to 38" x 84" x 29"H	4245

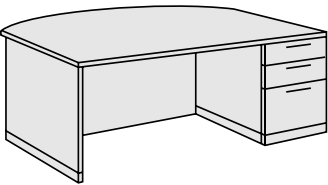

Single Pedestal Desk, Step Front, Bow Top

- Legal width pedestal
- Letter width pedestal for 60" desk
- Box|Box|File drawers on pedestal
- Pedestal lock included
- Optional center drawer
- Center modesty options
- Necessary hardware for attachment included
- **Must specify left or right pedestal sitting from user side**

PG3666SPB-SB	32" to 38" x 66" x 29"H	3640
PG3672SPB-SB	32" to 38" x 72" x 29"H	3745
PG3684SPB-SB	32" to 38" x 84" x 29"H	3965

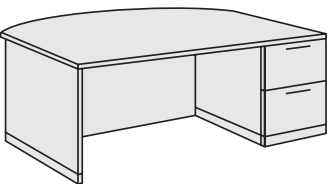

Single Pedestal Desk, Step Front, Bow Top

- Legal width pedestal
- Letter width pedestal for 60" desk
- File|File drawers on pedestal
- Pedestal lock included
- Optional center drawer
- Center modesty options
- Necessary hardware for attachment included
- **Must specify left or right pedestal sitting from user side**

PG3666SPF-SB	32" to 38" x 66" x 29"H	3640
PG3672SPF-SB	32" to 38" x 72" x 29"H	3745
PG3684SPF-SB	32" to 38" x 84" x 29"H	3965

TABLE DESKS

TAPERED WOOD LEG with METAL TRIM

Wood Finishes	Edge Details	Hardware Style	Available Options	List Price
<ul style="list-style-type: none"> CML Clear Maple COL Clear Oak on Maple AMB Amber on Maple CHY Cherry on Maple RCL Royal Cherry on Maple LWL Light Walnut on Maple ESP Espresso on Maple MHL Mahogany on Maple SMK Smoke on Maple 	(see p. 5) <ul style="list-style-type: none"> AR Arc BV Bevel CL Classic CV Cove EL Ellipse FL Fluted RD Radius RE Reveal SQ Square TD Traditional TR Transitional 	(see p. 6 for finishes) <ul style="list-style-type: none"> AR Arc CU Cube HE Heritage OR Orbit SW Swoop TA Tab FP Side-Routed Finger Pull 	<ul style="list-style-type: none"> CD Center Drawer AK-MP2 Articulating Keyboard Tray PK2 Pull-Out Keyboard Tray WG-1 Matte Black Grommet - 1 7/8" diameter I.D. WG-2 Matte Black Grommet - 1 7/8" diameter x 4 1/4" I.D. WG-SN Satin Nickel Grommet - 2 1/2" diameter I.D. (see page 10 for location information) (see page 11-13 for additional accessories)	<ul style="list-style-type: none"> \$250 470 395 80 100 120

To specify, include:

- Model Number
- Wood Finish
- Edge Detail
- Hardware Style
- Hardware Finish

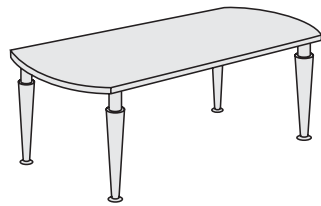

Arc End Table Desk, tapered wood leg with metal trim

- Tapered wood leg finished to match table top
- Satin nickel finish on metal trim
- Optional center drawer

Model #	Dimensions	List
PG3672ARC-TAP	36" x 72" x 29"H	\$2845
PG3678ARC-TAP	36" x 78" x 29"H	2960
PG3684ARC-TAP	36" x 84" x 29"H	3075

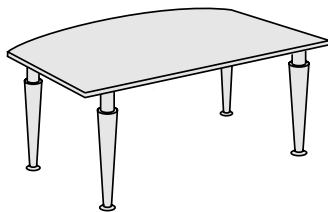

Bow Top Table Desk, tapered wood leg with metal trim

- Tapered wood leg finished to match table top
- Satin nickel finish on metal trim
- Optional center drawer

PG3672BOW-TAP	32" to 38" x 72" x 29"H	2905
PG3684BOW-TAP	32" to 38" x 84" x 29"H	3125

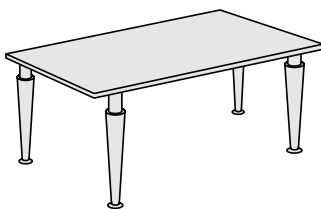

Rectangle Table Desk, tapered wood leg with metal trim

- Tapered wood leg finished to match table top
- Satin nickel finish on metal trim
- Optional center drawer

PG3636RT-TAP	36" x 36" x 29"H	1815
PG4242RT-TAP	42" x 42" x 29"H	2050
PG4848RT-TAP	48" x 48" x 29"H	2295
PG3672RT-TAP	36" x 72" x 29"H	2660
PG3684RT-TAP	36" x 84" x 29"H	2890

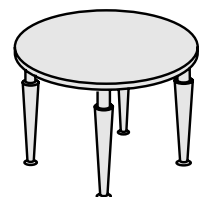

Round Table, tapered wood leg with metal trim

- Tapered wood leg finished to match table top
- Satin nickel finish on metal trim

PG36RD-TAP	36" Diameter	1935
PG42RD-TAP	42" Diameter	2180
PG48RD-TAP	48" Diameter	2425

TABLE DESKS

FLAIRED METAL LEG

Wood Finishes	Edge Details (see p. 5)	Hardware Style (see p. 6 for finishes)	Available Options	List Price
• CML Clear Maple	• AR Arc	• AR Arc	• CD Center Drawer	\$250
• COL Clear Oak on Maple	• BV Bevel	• CU Cube	• AK-MP2 Articulating Keyboard Tray	470
• AMB Amber on Maple	• CL Classic	• HE Heritage	• PK2 Pull-Out Keyboard Tray	395
• CHY Cherry on Maple	• CV Cove	• OR Orbit	• WG-1 Matte Black Grommet - 1 7/8" diameter I.D.	80
• RCL Royal Cherry on Maple	• EL Ellipse	• SW Swoop	• WG-2 Matte Black Grommet - 1 7/8" diameter x 4 1/4" I.D.	100
• LWL Light Walnut on Maple	• FL Fluted	• TA Tab	• WG-SN Satin Nickel Grommet - 2 1/2" diameter I.D.	120
• ESP Espresso on Maple	• RD Radius	• FP Side-Routed Finger Pull	(see page 10 for location information)	
• MHL Mahogany on Maple	• RE Reveal		(see page 11-13 for additional accessories)	
• SMK Smoke on Maple	• SQ Square			
	• TD Traditional			
	• TR Transitional			

To specify, include:

- Model Number
- Wood Finish
- Edge Detail
- Hardware Style
- Hardware Finish

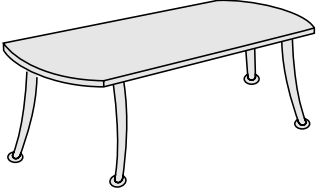
		Model #	Dimensions	List Price
	<ul style="list-style-type: none"> • Satin nickel finish on steel, flaired leg • Optional center drawer 	PG3672ARC-FML	36" x 72" x 29"H	\$2725
		PG3678ARC-FML	36" x 78" x 29"H	2840
		PG3684ARC-FML	36" x 84" x 29"H	2960

Arc End Table Desk, flaired metal leg

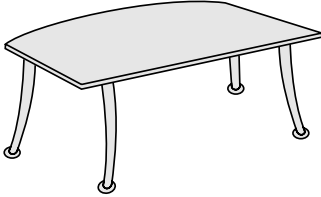
	<ul style="list-style-type: none"> • Satin nickel finish on steel, flaired leg • Optional center drawer 	PG3672BOW-FML	32" to 38" x 72" x 29"H	2795
		PG3684BOW-FML	32" to 38" x 84" x 29"H	3015

Bow Top Table Desk, flaired metal leg

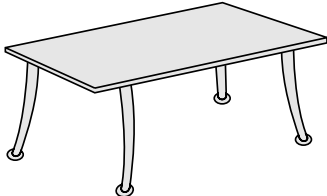
	<ul style="list-style-type: none"> • Satin nickel finish on steel, flaired leg • Optional center drawer 	PG3636RT-FML	36" x 36" x 29"H	1700
		PG4242RT-FML	42" x 42" x 29"H	1935
		PG4848RT-FML	48" x 48" x 29"H	2180
		PG3672RT-FML	36" x 72" x 29"H	2540
		PG3684RT-FML	36" x 84" x 29"H	2775

Rectangle Table Desk, flaired metal leg

	<ul style="list-style-type: none"> • Satin nickel finish on steel, flaired leg 	PG36RD-FML	36" Diameter	1820
		PG42RD-FML	42" Diameter	2060
		PG48RD-FML	48" Diameter	2310

Round Table, flaired metal leg

TABLE DESKS

METAL COLUMN LEG

To specify, include:

- Model Number
- Wood Finish
- Edge Detail
- Hardware Style
- Hardware Finish

Wood Finishes	Edge Details (see p. 5)	Hardware Style (see p. 6 for finishes)	Available Options	List Price
<ul style="list-style-type: none"> • CML Clear Maple • COL Clear Oak on Maple • AMB Amber on Maple • CHY Cherry on Maple • RCL Royal Cherry on Maple • LWL Light Walnut on Maple • ESP Espresso on Maple • MHL Mahogany on Maple • SMK Smoke on Maple 	<ul style="list-style-type: none"> • AR Arc • BV Bevel • CL Classic • CV Cove • EL Ellipse • FL Fluted • RD Radius • RE Reveal • SQ Square • TD Traditional • TR Transitional 	<ul style="list-style-type: none"> • AR Arc • CU Cube • HE Heritage • OR Orbit • SW Swoop • TA Tab • FP Side-Routed Finger Pull 	<ul style="list-style-type: none"> • CD Center Drawer • AK-MP2 Articulating Keyboard Tray • PK2 Pull-Out Keyboard Tray • WG-1 Matte Black Grommet - 1 7/8" diameter I.D. • WG-2 Matte Black Grommet - 1 7/8" diameter x 4 1/4" I.D. • WG-SN Satin Nickel Grommet - 2 1/2" diameter I.D. 	<ul style="list-style-type: none"> \$250 470 395 80 100 120

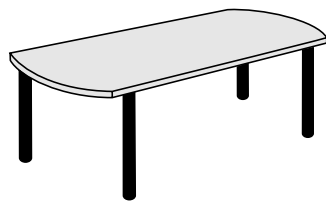

Arc End Table Desk, metal column leg

- Metal column leg available in matte black (-BLK) or satin nickel (-SN)
- Optional locking casters available in black only
- Optional center drawer

Model #	Dimensions	List Price
PG3672ARC-ML	36" x 72" x 29"H	\$2380
PG3678ARC-ML	36" x 78" x 29"H	2495
PG3684ARC-ML	36" x 84" x 29"H	2610
PGML-CAS	Optional locking black casters	150 set

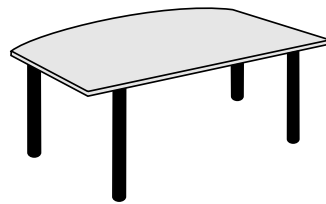

Bow Top Table Desk, metal column leg

- Metal column leg available in matte black (-BLK) or satin nickel (-SN)
- Optional locking casters available in black only
- Optional center drawer

PG3672BOW-ML	32" to 38" x 72" x 29"H	2470
PG3684BOW-ML	32" to 38" x 84" x 29"H	2685
PGML-CAS	Optional locking black casters	150 set

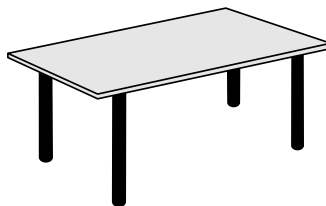

Rectangle Table Desk, metal column leg

- Metal column leg available in matte black (-BLK) or satin nickel (-SN)
- Optional locking casters available in black only
- Optional center drawer

PG3636RT-ML	36" x 36" x 29"H	1350
PG4242RT-ML	42" x 42" x 29"H	1585
PG4848RT-ML	48" x 48" x 29"H	1830
PG3672RT-ML	36" x 72" x 29"H	2195
PG3684RT-ML	36" x 84" x 29"H	2430
PGML-CAS	Optional locking black casters	150 set

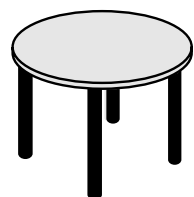

Round Table, metal column leg

- Metal column leg available in matte black (-BLK) or satin nickel (-SN)
- Optional locking casters available in black only

PG36RD-ML	36" Diameter	1470
PG42RD-ML	42" Diameter	1715
PG48RD-ML	48" Diameter	1960
PGML-CAS	Optional locking black casters	150 set

CONFERENCING DESKS

TAPERED WOOD LEG with METAL TRIM

Wood Finishes	Edge Details (see p. 5)	Hardware Style (see p. 6 for finishes)	Available Options	List Price
• CML Clear Maple	• AR Arc	• AR Arc	• CD Center Drawer	\$250
• COL Clear Oak on Maple	• BV Bevel	• CU Cube	• AK-MP2 Articulating Keyboard Tray	470
• AMB Amber on Maple	• CL Classic	• HE Heritage	• PK2 Pull-Out Keyboard Tray	395
• CHY Cherry on Maple	• CV Cove	• OR Orbit	• WG-1 Matte Black Grommet - 1 7/8" diameter I.D.	80
• RCL Royal Cherry on Maple	• EL Ellipse	• SW Swoop	• WG-2 Matte Black Grommet - 1 7/8" diameter x 4 1/4" I.D.	100
• LWL Light Walnut on Maple	• FL Fluted	• TA Tab	• WG-SN Satin Nickel Grommet - 2 1/2" diameter I.D.	120
• ESP Espresso on Maple	• RD Radius	• FP Side-Routed Finger Pull	(see page 10 for location information)	
• MHL Mahogany on Maple	• RE Reveal		(see page 11-13 for additional accessories)	
• SMK Smoke on Maple	• SQ Square			
	• TD Traditional			
	• TR Transitional			

To specify, include:

- Model Number
- Wood Finish
- Edge Detail
- Hardware Style
- Hardware Finish

	Model #	Dimensions	List Price
--	---------	------------	------------

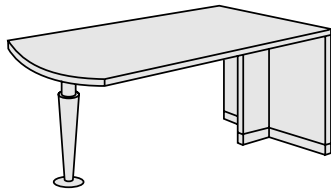

- Tapered wood leg finished to match table top
- Satin nickel finish on metal trim
- Optional center drawer
- **Must specify left or right from user side**

PG3072CD-ARC-TAP	30" x 72" x 29"H	\$2840
PG3672CD-ARC-TAP	36" x 72" x 29"H	3055
PG3684CD-ARC-TAP	36" x 84" x 29"H	3165

Arc End Conferencing Desk, tapered wood leg with metal trim

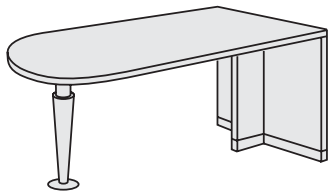

- Tapered wood leg finished to match table top
- Satin nickel finish on metal trim
- Optional center drawer
- **Must specify left or right from user side**

PG3072CD-BUL-TAP	30" x 72" x 29"H	2950
PG3672CD-BUL-TAP	36" x 72" x 29"H	3165
PG3684CD-BUL-TAP	36" x 84" x 29"H	3275

Bullet Conferencing Desk, tapered wood leg with metal trim

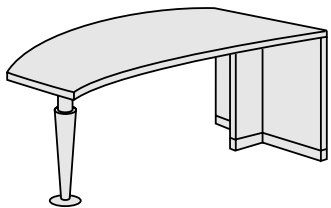

- Tapered wood leg finished to match table top
- Satin nickel finish on metal trim
- Optional center drawer
- **Must specify left or right from user side**

PG3672CD-SLF-TAP	36" x 72" x 29"H	3385
PG3678CD-SLF-TAP	36" x 78" x 29"H	3550
PG3684CD-SLF-TAP	36" x 84" x 29"H	3710

Sailfin Conferencing Desk, tapered wood leg with metal trim

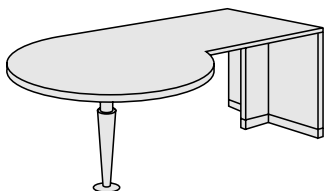

- Tapered wood leg finished to match table top
- Satin nickel finish on metal trim
- Optional center drawer
- **Must specify left or right from user side**
- **Must specify conference round in or out**

PG3072CD-PTP-TAP	30" x 42" Dia. x 72" x 29"H	3330
PG3084CD-PTP-TAP	30" x 42" Dia. x 84" x 29"H	3495
PG3684CD-PTP-TAP	36" x 48" Dia. x 84" x 29"H	3820

P-Top Conferencing Desk, tapered wood leg with metal trim

CONFERRING DESKS

METAL COLUMN LEG

Wood Finishes	Edge Details	Hardware Style	Available Options	List Price
<ul style="list-style-type: none"> • CML Clear Maple • COL Clear Oak on Maple • AMB Amber on Maple • CHY Cherry on Maple • RCL Royal Cherry on Maple • LWL Light Walnut on Maple • ESP Espresso on Maple • MHL Mahogany on Maple • SMK Smoke on Maple 	(see p. 5) <ul style="list-style-type: none"> • AR Arc • BV Bevel • CL Classic • CV Cove • EL Ellipse • FL Fluted • RD Radius • RE Reveal • SQ Square • TD Traditional • TR Transitional 	(see p. 6 for finishes) <ul style="list-style-type: none"> • AR Arc • CU Cube • HE Heritage • OR Orbit • SW Swoop • TA Tab • FP Side-Routed Finger Pull 	<ul style="list-style-type: none"> • CD Center Drawer • PGMOD Modesty Options • -WD Full Wood Modesty • -PERFWD Perforated Wood Modesty • -PERFMTL Perforated Metal Modesty • -FLMTL Full Metal Modesty • WG-1 Matte Black Grommet - 1 7/8" diameter I.D. • WG-2 Matte Black Grommet - 1 7/8" diameter x 4 1/4" I.D. • WG-AB Antique Brass Grommet - 2 1/2" diameter I.D. • WG-SN Satin Nickel Grommet - 2 1/2" diameter I.D. (see page 10 for location information) (see page 11-13 for additional accessories)	\$250 495 585 695 595 80 100 120 120

To specify, include:

- Model Number
- Wood Finish
- Edge Detail
- Hardware Style
- Hardware Finish

Model #	Dimensions	List Price
---------	------------	------------

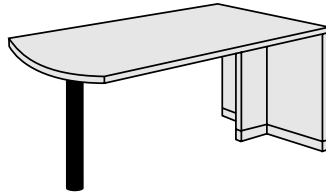

- 6" diameter matte black metal column leg
- Optional center drawer
- Optional modesty panel
- **Must specify left or right from user side**

PG3072CD-ARC-ML	30" x 72" x 29"H	\$2405
PG3672CD-ARC-ML	36" x 72" x 29"H	2620
PG3684CD-ARC-ML	36" x 84" x 29"H	2730

Arc End Conferencing Desk, metal column leg

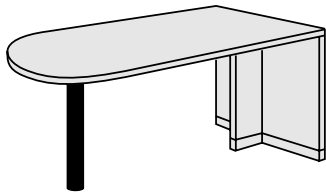

- 6" diameter matte black metal column leg
- Optional center drawer
- Optional modesty panel
- **Must specify left or right from user side**

PG3072CD-BUL-ML	30" x 72" x 29"H	2510
PG3672CD-BUL-ML	36" x 72" x 29"H	2730
PG3684CD-BUL-ML	36" x 84" x 29"H	2840

Bullet Conferencing Desk, metal column leg

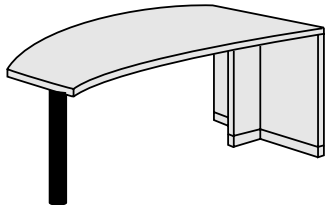

- 6" diameter matte black metal column leg
- Optional center drawer
- Optional modesty panel
- **Must specify left or right from user side**

PG3672CD-SLF-ML	36" x 72" x 29"H	2950
PG3678CD-SLF-ML	36" x 78" x 29"H	3115
PG3684CD-SLF-ML	36" x 84" x 29"H	3385

Sailfin Conferencing Desk, metal column leg

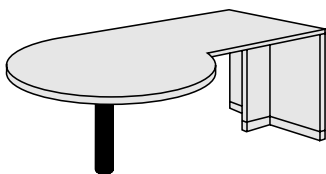

- 6" diameter matte black metal column leg
- Optional center drawer
- Optional modesty panel
- **Must specify left or right from user side**
- **Must specify conference round in or out**

PG3072CD-PTP-ML	30" x 42" Dia. x 72" x 29"H	2895
PG3084CD-PTP-ML	30" x 42" Dia. x 84" x 29"H	3055
PG3684CD-PTP-ML	36" x 48" Dia. x 84" x 29"H	3385

P-Top Conferencing Desk, metal column leg

CONFERRING DESKS

WOOD COLUMN LEG

Wood Finishes	Edge Details (see p. 5)	Hardware Style (see p. 6 for finishes)	Available Options	List Price
<ul style="list-style-type: none"> CML Clear Maple COL Clear Oak on Maple AMB Amber on Maple CHY Cherry on Maple RCL Royal Cherry on Maple LWL Light Walnut on Maple ESP Espresso on Maple MHL Mahogany on Maple SMK Smoke on Maple 	<ul style="list-style-type: none"> AR Arc BV Bevel CL Classic CV Cove EL Ellipse FL Fluted RD Radius RE Reveal SQ Square TD Traditional TR Transitional 	<ul style="list-style-type: none"> AR Arc CU Cube HE Heritage OR Orbit SW Swoop TA Tab FP Side-Routed Finger Pull 	<ul style="list-style-type: none"> CD Center Drawer PGMOD Modesty Options -WD Full Wood Modesty -PERFWD Perforated Wood Modesty -PERFML Perforated Metal Modesty -FLMTL Full Metal Modesty WG-1 Matte Black Grommet - 1 7/8" diameter I.D. WG-2 Matte Black Grommet - 1 7/8" diameter x 4 1/4" I.D. WG-AB Antique Brass Grommet - 2 1/2" diameter I.D. WG-SN Satin Nickel Grommet - 2 1/2" diameter I.D. 	<ul style="list-style-type: none"> \$250 495 585 695 595 80 100 120 120

To specify, include:

- Model Number
- Wood Finish
- Edge Detail
- Hardware Style
- Hardware Finish

	Model #	Dimensions	List Price
--	---------	------------	------------

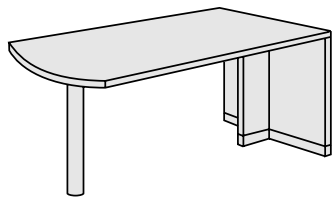

- 6" diameter wood column leg finished to match table top
- Optional center drawer
- Optional modesty panel
- **Must specify left or right from user side**

PG3072CD-ARC-WDC	30" x 72" x 29"H	\$2510
PG3672CD-ARC-WDC	36" x 72" x 29"H	2730
PG3684CD-ARC-WDC	36" x 84" x 29"H	2840

Arc End Conferencing Desk, wood column leg

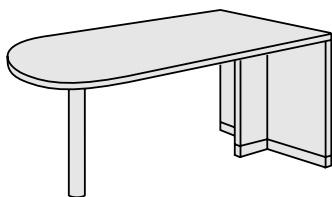

- 6" diameter wood column leg finished to match table top
- Optional center drawer
- Optional modesty panel
- **Must specify left or right from user side**

PG3072CD-BUL-WDC	30" x 72" x 29"H	2620
PG3672CD-BUL-WDC	36" x 72" x 29"H	2840
PG3684CD-BUL-WDC	36" x 84" x 29"H	2950

Bullet Conferencing Desk, wood column leg

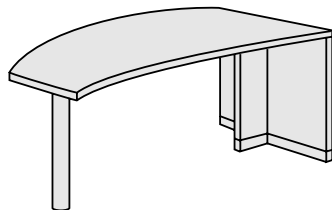

- 6" diameter wood column leg finished to match table top
- Optional center drawer
- Optional modesty panel
- **Must specify left or right from user side**

PG3672CD-SLF-WDC	36" x 72" x 29"H	3055
PG3678CD-SLF-WDC	36" x 78" x 29"H	3225
PG3684CD-SLF-WDC	36" x 84" x 29"H	3495

Sailfin Conferencing Desk, wood column leg

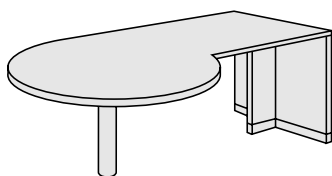

- 6" diameter wood column leg finished to match table top
- Optional center drawer
- Optional modesty panel
- **Must specify left or right from user side**
- **Must specify conference round in or out**

PG3072CD-PTP-WDC	30" x 42" Dia. x 72" x 29"H	3005
PG3084CD-PTP-WDC	30" x 42" Dia. x 84" x 29"H	3165
PG3684CD-PTP-WDC	36" x 48" Dia. x 84" x 29"H	3495

P-Top Conferencing Desk, wood column leg

RUN-OFF DESKS

TAPERED WOOD LEG with METAL TRIM

To specify, include:

- Model Number
- Wood Finish
- Edge Detail
- Hardware Style
- Hardware Finish

Wood Finishes	Edge Details	Hardware Style	Available Options	List Price
<ul style="list-style-type: none"> • CML Clear Maple • COL Clear Oak on Maple • AMB Amber on Maple • CHY Cherry on Maple • RCL Royal Cherry on Maple • LWL Light Walnut on Maple • ESP Espresso on Maple • MHL Mahogany on Maple • SMK Smoke on Maple 	(see p. 5) <ul style="list-style-type: none"> • AR Arc • BV Bevel • CL Classic • CV Cove • EL Ellipse • FL Fluted • RD Radius • RE Reveal • SQ Square • TD Traditional • TR Transitional 	(see p. 6 for finishes) <ul style="list-style-type: none"> • AR Arc • CU Cube • HE Heritage • OR Orbit • SW Swoop • TA Tab • FP Side-Routed Finger Pull 	<ul style="list-style-type: none"> • CD Center Drawer • AK-MP2 Articulating Keyboard Tray • PK2 Pull-Out Keyboard Tray • WG-1 Matte Black Grommet - 1 7/8" diameter I.D. • WG-2 Matte Black Grommet - 1 7/8" diameter x 4 1/4" I.D. • WG-SN Satin Nickel Grommet - 2 1/2" diameter I.D. (see page 10 for location information) (see page 11-13 for additional accessories) 	<ul style="list-style-type: none"> \$250 470 395 80 100 120

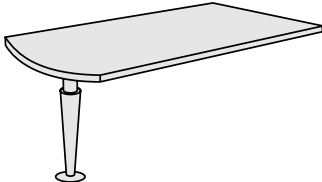
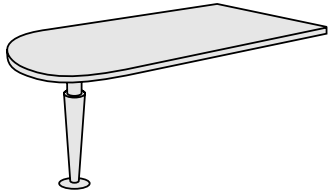
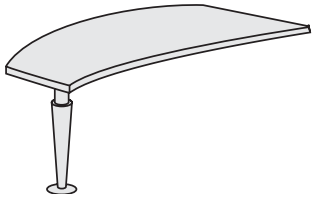
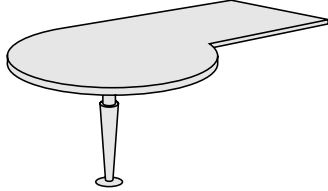
		Model #	Dimensions	List Price
	<ul style="list-style-type: none"> • Tapered wood leg finished to match table top • Satin nickel finish on metal trim • Optional center drawer • Must specify left or right extension from credenza 	PG3060RO-ARC-TAP	30" x 60" x 29"H	\$1965
		PG3066RO-ARC-TAP	30" x 66" x 29"H	2295
		PG3672RO-ARC-TAP	36" x 72" x 29"H	2620
	<ul style="list-style-type: none"> • Tapered wood leg finished to match table top • Satin nickel finish on metal trim • Optional center drawer • Must specify left or right extension from credenza 	PG3060RO-BUL-TAP	30" x 60" x 29"H	2075
		PG3066RO-BUL-TAP	30" x 66" x 29"H	2405
		PG3672RO-BUL-TAP	36" x 72" x 29"H	2730
	<ul style="list-style-type: none"> • Tapered wood leg finished to match table top • Satin nickel finish on metal trim • Optional center drawer • Must specify left or right extension from credenza 	PG3666RO-SLF-TAP	36" x 66" x 29"H	2730
		PG3672RO-SLF-TAP	36" x 72" x 29"H	2950
	<ul style="list-style-type: none"> • Tapered wood leg finished to match table top • Satin nickel finish on metal trim • Optional center drawer • Must specify left or right extension from credenza • Must specify conference round in or out 	PG3066RO-PTP-TAP	30" x 42" Dia. x 66" x 29"H	2730
		PG3672RO-PTP-TAP	36" x 48" Dia. x 72" x 29"H	3055

P-Top Run-Off Desk, tapered wood leg with metal trim

RUN-OFF DESKS

METAL COLUMN LEG

Wood Finishes	Edge Details (see p. 5)	Hardware Style (see p. 6 for finishes)	Available Options	List Price
• CML Clear Maple	• AR Arc	• AR Arc	• CD Center Drawer	\$250
• COL Clear Oak on Maple	• BV Bevel	• CU Cube	• AK-MP2 Articulating Keyboard Tray	470
• AMB Amber on Maple	• CL Classic	• HE Heritage	• PK2 Pull-Out Keyboard Tray	395
• CHY Cherry on Maple	• CV Cove	• OR Orbit	• WG-1 Matte Black Grommet - 1 7/8" diameter I.D.	80
• RCL Royal Cherry on Maple	• EL Ellipse	• SW Swoop	• WG-2 Matte Black Grommet - 1 7/8" diameter x 4 1/4" I.D.	100
• LWL Light Walnut on Maple	• FL Fluted	• TA Tab	• WG-SN Satin Nickel Grommet - 2 1/2" diameter I.D.	120
• ESP Espresso on Maple	• RD Radius	• FP Side-Routed Finger Pull	(see page 10 for location information)	
• MHL Mahogany on Maple	• RE Reveal		(see page 11-13 for additional accessories)	
• SMK Smoke on Maple	• SQ Square			
	• TD Traditional			
	• TR Transitional			

To specify, include:

- Model Number
- Wood Finish
- Edge Detail
- Hardware Style
- Hardware Finish

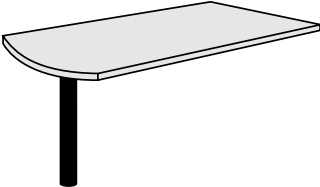
		Model #	Dimensions	List Price
	• 6" diameter matte black metal column leg	PG3060RO-ARC-ML	30" x 60" x 29"H	\$1530
	• Optional center drawer	PG3066RO-ARC-ML	30" x 66" x 29"H	1860
	• Must specify left or right extension from credenza	PG3672RO-ARC-ML	36" x 72" x 29"H	2185

Arc End Run-Off Desk, metal column leg

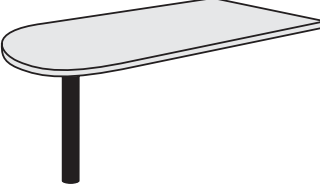
	• 6" diameter matte black metal column leg	PG3060RO-BUL-ML	30" x 60" x 29"H	1640
	• Optional center drawer	PG3066RO-BUL-ML	30" x 66" x 29"H	1965
	• Must specify left or right extension from credenza	PG3672RO-BUL-ML	36" x 72" x 29"H	2295

Bullet Run-Off Desk, metal column leg

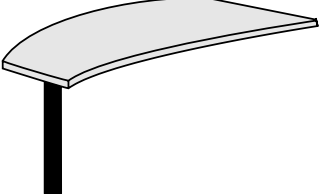
	• 6" diameter matte black metal column leg	PG3666RO-SLF-ML	36" x 66" x 29"H	2295
	• Optional center drawer	PG3672RO-SLF-ML	36" x 72" x 29"H	2510

Sailfin Run-Off Desk, metal column leg

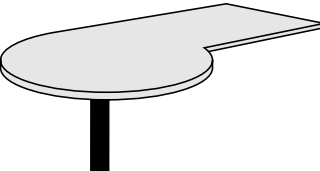
	• 6" diameter matte black metal column leg	PG3066RO-PTP-ML	30" x 42" Dia. x 66" x 29"H	2295
	• Optional center drawer	PG3672RO-PTP-ML	36" x 48" Dia. x 72" x 29"H	2620

P-Top Run-Off Desk, metal column leg

RUN-OFF DESKS

WOOD COLUMN LEG

Wood Finishes	Edge Details	Hardware Style	Available Options	List Price
<ul style="list-style-type: none"> CML Clear Maple COL Clear Oak on Maple AMB Amber on Maple CHY Cherry on Maple RCL Royal Cherry on Maple LWL Light Walnut on Maple ESP Espresso on Maple MHL Mahogany on Maple SMK Smoke on Maple 	(see p. 5) <ul style="list-style-type: none"> AR Arc BV Bevel CL Classic CV Cove EL Ellipse FL Fluted RD Radius RE Reveal SQ Square TD Traditional TR Transitional 	(see p. 6 for finishes) <ul style="list-style-type: none"> AR Arc CU Cube HE Heritage OR Orbit SW Swoop TA Tab FP Side-Routed Finger Pull 	<ul style="list-style-type: none"> CD Center Drawer AK-MP2 Articulating Keyboard Tray PK2 Pull-Out Keyboard Tray WG-1 Matte Black Grommet - 1 7/8" diameter I.D. WG-2 Matte Black Grommet - 1 7/8" diameter x 4 1/4" I.D. WG-AB Antique Brass Grommet - 2 1/2" diameter I.D. WG-SN Satin Nickel Grommet - 2 1/2" diameter I.D. (see page 10 for location information) (see page 11-13 for additional accessories) 	<ul style="list-style-type: none"> \$250 470 395 80 100 120 120

To specify, include:

- Model Number
- Wood Finish
- Edge Detail
- Hardware Style
- Hardware Finish

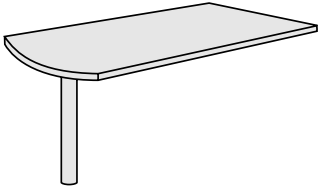
	Model #	Dimensions	List Price
 <ul style="list-style-type: none"> • 6" diameter wood column leg finished to match table top • Optional center drawer • Must specify left or right extension from credenza 	PG3060RO-ARC-WDC	30" x 60" x 29"H	\$1640
	PG3066RO-ARC-WDC	30" x 66" x 29"H	1965
	PG3672RO-ARC-WDC	36" x 72" x 29"H	2295

Arc End Run-Off Desk, wood column leg

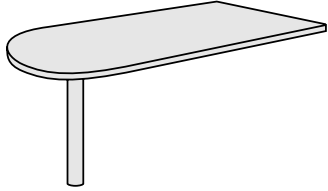
 <ul style="list-style-type: none"> • 6" diameter wood column leg finished to match table top • Optional center drawer • Must specify left or right extension from credenza 	PG3060RO-BUL-WDC	30" x 60" x 29"H	1750
	PG3066RO-BUL-WDC	30" x 66" x 29"H	2075
	PG3672RO-BUL-WDC	36" x 72" x 29"H	2405

Bullet Run-Off Desk, wood column leg

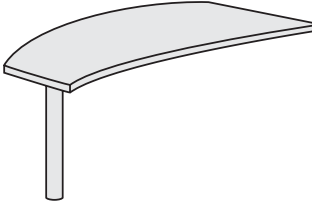
 <ul style="list-style-type: none"> • 6" diameter wood column leg finished to match table top • Optional center drawer • Must specify left or right extension from credenza 	PG3666RO-SLF-WDC	36" x 66" x 29"H	2405
	PG3672RO-SLF-WDC	36" x 72" x 29"H	2620

Sailfin Run-Off Desk, wood column leg

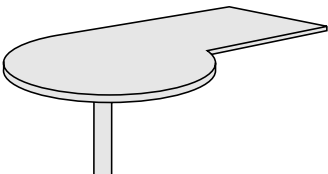
 <ul style="list-style-type: none"> • 6" diameter wood column leg finished to match table top • Optional center drawer • Must specify left or right extension from credenza • Must specify conference round in or out 	PG3066RO-PTP-WDC	30" x 42" Dia. x 66" x 29"H	2405
	PG3672RO-PTP-WDC	36" x 48" Dia. x 72" x 29"H	2730

P-Top Run-Off Desk, wood column leg

BRIDGES UNITS

Wood Finishes	Edge Details	Hardware Style	Available Options	List Price
<ul style="list-style-type: none"> • CML Clear Maple • COL Clear Oak on Maple • AMB Amber on Maple • CHY Cherry on Maple • RCL Royal Cherry on Maple • LWL Light Walnut on Maple • ESP Espresso on Maple • MHL Mahogany on Maple • SMK Smoke on Maple 	(see p. 5) <ul style="list-style-type: none"> • AR Arc • BV Bevel • CL Classic • CV Cove • EL Ellipse • FL Fluted • RD Radius • RE Reveal • SQ Square • TD Traditional • TR Transitional 	(see p. 6 for finishes) <ul style="list-style-type: none"> • AR Arc • CU Cube • HE Heritage • OR Orbit • SW Swoop • TA Tab • FP Side-Routed Finger Pull 	<ul style="list-style-type: none"> • CD Center Drawer • AK-MP2 Articulating Keyboard Tray • PK2 Pull-Out Keyboard Tray • WAP Wire Access Panel (full modesty only) • WG-1 Matte Black Grommet - 1 7/8" diameter I.D. • WG-2 Matte Black Grommet - 1 7/8" diameter x 4 1/4" I.D. • WG-AB Antique Brass Grommet - 2 1/2" diameter I.D. • WG-SN Satin Nickel Grommet - 2 1/2" diameter I.D. (see page 10 for location information) (see page 11-13 for additional accessories)	<ul style="list-style-type: none"> \$250 470 395 215 80 100 120 120

- To specify, include:**
- Model Number
 - Wood Finish
 - Edge Detail
 - Hardware Style
 - Hardware Finish

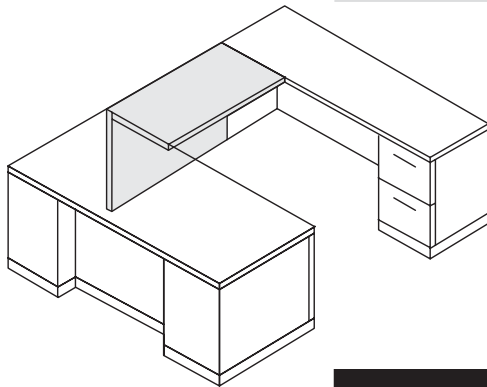

For non-standard length bridges, refer to the next larger size, then add \$210 to the list price for the cut down charge.

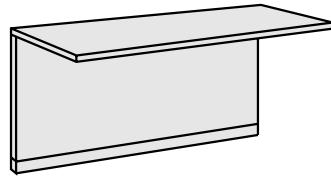

Bridge Unit, full modesty

- For U-shaped configurations to join free-standing single pedestal desks, credenzas, or corner units
- Cannot attach at drawer pedestal or hinged door locations
- Necessary hardware for attachment included
- **Must specify left or right sitting**

Model #	Dimensions	List Price
PGB2030	20" x 30" x 29"H	\$850
PGB2036	20" x 36" x 29"H	920
PGB2042	20" x 42" x 29"H	980
PGB2048	20" x 48" x 29"H	1050
PGB2060	20" x 60" x 29"H	1180
PGB2430	24" x 30" x 29"H	920
PGB2436	24" x 36" x 29"H	980
PGB2442	24" x 42" x 29"H	1050
PGB2448	24" x 48" x 29"H	1115
PGB2460	24" x 60" x 29"H	1245

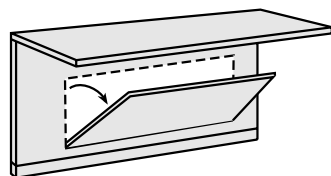

Bridge Unit, hinged modesty

- 32" wide hinged opening allows access to electrical and communication connections
- For U-shaped configurations to join free-standing single pedestal desks, credenzas, or corner units
- Cannot attach at drawer pedestal or hinged door locations
- Necessary hardware for attachment included
- **Must specify left or right sitting**

PGB2036-HM	20" x 36" x 29"H	1160
PGB2042-HM	20" x 42" x 29"H	1220
PGB2048-HM	20" x 48" x 29"H	1290
PGB2060-HM	20" x 60" x 29"H	1420
PGB2436-HM	24" x 36" x 29"H	1360
PGB2442-HM	24" x 42" x 29"H	1425
PGB2448-HM	24" x 48" x 29"H	1490
PGB2460-HM	24" x 60" x 29"H	1620

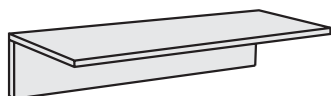

Bridge Unit, 8" modesty

- 8" modesty allows access to electrical and communication connections
- For U-shaped configurations to join free-standing single pedestal desks, credenzas, or corner units
- Cannot attach at drawer pedestal or hinged door locations
- Necessary hardware for attachment included
- **Must specify left or right sitting**

PGB2030-A	20" x 30" x 29"H	790
PGB2036-A	20" x 36" x 29"H	850
PGB2042-A	20" x 42" x 29"H	920
PGB2048-A	20" x 48" x 29"H	980
PGB2430-A	24" x 30" x 29"H	850
PGB2436-A	24" x 36" x 29"H	920
PGB2442-A	24" x 42" x 29"H	980
PGB2448-A	24" x 48" x 29"H	1050

BRIDGES UNITS WITH CURVED WORKING EDGE

To specify, include:

- Model Number
- Wood Finish
- Edge Detail
- Hardware Style
- Hardware Finish

Wood Finishes	Edge Details	Hardware Style	Available Options	List Price
<ul style="list-style-type: none"> • CML Clear Maple • COL Clear Oak on Maple • AMB Amber on Maple • CHY Cherry on Maple • RCL Royal Cherry on Maple • LWL Light Walnut on Maple • ESP Espresso on Maple • MHL Mahogany on Maple • SMK Smoke on Maple 	(see p. 5) <ul style="list-style-type: none"> • AR Arc • BV Bevel • CL Classic • CV Cove • EL Ellipse • FL Fluted • RD Radius • RE Reveal • SQ Square • TD Traditional • TR Transitional 	(see p. 6 for finishes) <ul style="list-style-type: none"> • AR Arc • CU Cube • HE Heritage • OR Orbit • SW Swoop • TA Tab • FP Side-Routed Finger Pull 	<ul style="list-style-type: none"> • CD Center Drawer • AK-MP2 Articulating Keyboard Tray • PK2 Pull-Out Keyboard Tray • WAP Wire Access Panel (full modesty only) • WG-1 Matte Black Grommet - 1 7/8" diameter I.D. • WG-2 Matte Black Grommet - 1 7/8" diameter x 4 1/4" I.D. • WG-AB Antique Brass Grommet - 2 1/2" diameter I.D. • WG-SN Satin Nickel Grommet - 2 1/2" diameter I.D. (see page 10 for location information) (see page 11-13 for additional accessories) 	<ul style="list-style-type: none"> \$250 470 395 215 80 100 120 120

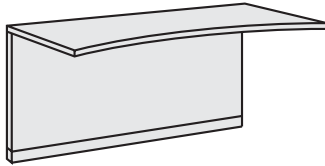
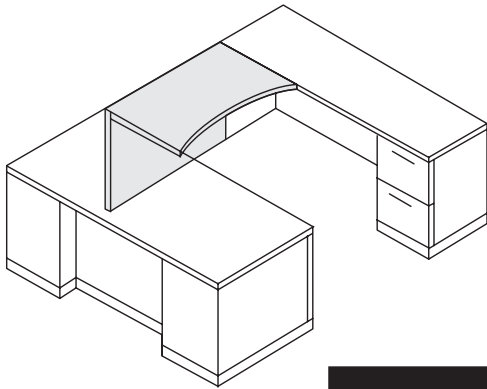

Bridge Unit with curved working edge, full modesty

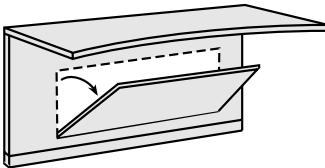

Bridge Unit with curved working edge, hinged modesty

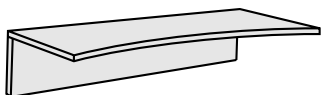

Bridge Unit with curved working edge, 8" modesty

	Model #	Dimensions	List
<ul style="list-style-type: none"> • For U-shaped configurations to join free-standing single pedestal desks, credenzas, or corner units • Cannot attach at drawer pedestal or hinged door locations • Necessary hardware for attachment included • Must specify left or right sitting 	PGBC2436	24" x 36" x 29"H	\$1120
	PGBC2442	24" x 42" x 29"H	1185
	PGBC2448	24" x 48" x 29"H	1250
<ul style="list-style-type: none"> • 32" wide hinged opening allows access to electrical and communication connections • For U-shaped configurations to join free-standing single pedestal desks, credenzas, or corner units • Cannot attach at drawer pedestal or hinged door locations • Necessary hardware for attachment included • Must specify left or right sitting 	PGBC2436-HM	24" x 36" x 29"H	1495
	PGBC2442-HM	24" x 42" x 29"H	1565
	PGBC2448-HM	24" x 48" x 29"H	1625
<ul style="list-style-type: none"> • 8" modesty allows access to electrical and communication connections • For U-shaped configurations to join free-standing single pedestal desks, credenzas, or corner units • Cannot attach at drawer pedestal or hinged door locations • Necessary hardware for attachment included • Must specify left or right sitting 	PGBC2436-A	24" x 36" x 29"H	1055
	PGBC2442-A	24" x 42" x 29"H	1120
	PGBC2448-A	24" x 48" x 29"H	1185

MODULAR RETURNS | COMPONENTS

- To specify, include:**
- Model Number
 - Wood Finish
 - Edge Detail
 - Hardware Style
 - Hardware Finish
 - Left or right sitting
 - List components left to right

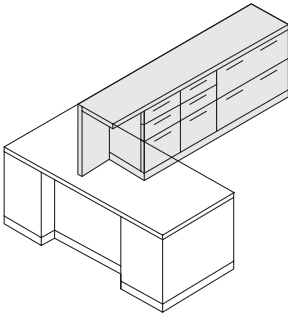

Wood Finishes	Edge Details	Hardware Style	Available Options	List Price
<ul style="list-style-type: none"> • CML Clear Maple • COL Clear Oak on Maple • AMB Amber on Maple • CHY Cherry on Maple • RCL Royal Cherry on Maple • LWL Light Walnut on Maple • ESP Espresso on Maple • MHL Mahogany on Maple • SMK Smoke on Maple 	<ul style="list-style-type: none"> (see p. 5) • AR Arc • BV Bevel • CL Classic • CV Cove • EL Ellipse • FL Fluted • RD Radius • RE Reveal • SQ Square • TD Traditional • TR Transitional 	<ul style="list-style-type: none"> (see p. 6 for finishes) • AR Arc • CU Cube • HE Heritage • OR Orbit • SW Swoop • TA Tab • FP Side-Routed Finger Pull 	<ul style="list-style-type: none"> • AK-MP2 Articulating Keyboard Tray • PK2 Pull-Out Keyboard Tray • WAP Wire Access Panel (full modesty only) • HM Hinged Modesty • HD-PTR18 Pull-Out Shelf (for 18" Hinged Door Component) • HD-PTR36 Pull-Out Shelf (for 36" Hinged Door Component) • LK Lock (per pedestal) • WG-1 Matte Black Grommet - 1 7/8" diameter I.D. • WG-2 Matte Black Grommet - 1 7/8" diameter x 4 1/4" I.D. • WG-AB Antique Brass Grommet - 2 1/2" diameter I.D. • WG-SN Satin Nickel Grommet - 2 1/2" diameter I.D. 	<ul style="list-style-type: none"> \$470 395 215 240 195 250 80 80 100 120 120

Modular Returns are reconfigurable in the field, allowing the pedestal positions to be changed for further flexibility. To specify a Modular Return, select from the available worksurfaces, modesties, and components listed below. Return Units must be specified as a left or right return (as you are sitting at the desk), then specify the components in the unit, left to right. All units are assembled at the factory and shipped as one unit, unless otherwise specified. All components and kneespace areas have finished backs. **All BBF and FF pedestals specified for returns are legal width.** To ensure proper configuration and connecting hardware, a diagram should be included when specifying Modular Returns.

For non-standard length returns, refer to the next larger size, then add \$210 to the list price for the cut down charge.

Model #	Dimensions	List Price	Model #	Dimensions	List Price
WORKSURFACE & MODESTY ASSEMBLY:					
PG2036RA	20" x 36" x 29"H	\$1500	PG2436RA	24" x 36" x 29"H	\$1620
PG2042RA	20" x 42" x 29"H	1610	PG2442RA	24" x 42" x 29"H	1735
PG2048RA	20" x 48" x 29"H	1720	PG2448RA	24" x 48" x 29"H	1840
PG2054RA	20" x 54" x 29"H	1825	PG2454RA	24" x 54" x 29"H	1950
PG2060RA	20" x 60" x 29"H	1935	PG2460RA	24" x 60" x 29"H	2060
PG2072RA	20" x 72" x 29"H	2160	PG2472RA	24" x 72" x 29"H	2280
PG2084RA	20" x 84" x 29"H	2375	PG2484RA	24" x 84" x 29"H	2495

18 1/2"W COMPONENTS:



PG18BBF
Box/Box/File Drawer

\$460



PG18FF
File/File Drawer

\$460

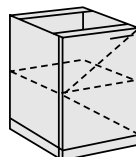

PG18HD
Single Hinged Door
One Adjustable Shelf
(specify hinge right or hinge left)

\$325

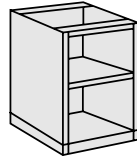

PG18BC
Open Bookcase
One Adjustable Shelf

\$295



PGSEP
End Panel

\$240

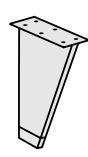

PGSU
Support Panel

\$190

30" | 36"W COMPONENTS:

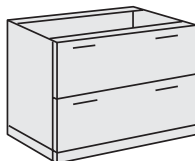

PG30LF
Lateral File
Locks Included
\$650

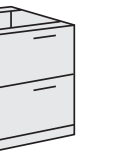

PG36LF
Lateral File
Locks Included
\$685

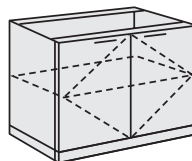

PG36HD
Double Hinged Door
One Adjustable Shelf
\$395

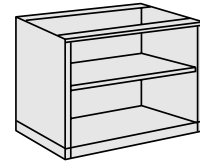

PG36BC
Open Bookcase
One Adjustable Shelf
\$325

PRECONFIGURED RETURNS

NOTE: Preconfigured Returns are NOT reconfigurable in the field.

To specify, include:

- Model Number
- Wood Finish
- Edge Detail
- Hardware Style
- Hardware Finish

Wood Finishes	Edge Details	Hardware Style	Available Options	List Price
• CML Clear Maple	(see p. 5)	(see p. 6 for finishes)	• AK-MP2 Articulating Keyboard Tray	\$470
• COL Clear Oak on Maple	• AR Arc	• AR Arc	• PK2 Pull-Out Keyboard Tray	395
• AMB Amber on Maple	• BV Bevel	• CU Cube	• WAP Wire Access Panel (full modesty only)	215
• CHY Cherry on Maple	• CL Classic	• HE Heritage	• HM Hinged Modesty	240
• RCL Royal Cherry on Maple	• CV Cove	• OR Orbit	• LK Lock (per pedestal)	80
• LWL Light Walnut on Maple	• EL Ellipse	• SW Swoop	• WG-1 Matte Black Grommet - 1 7/8" diameter I.D.	80
• ESP Espresso on Maple	• FL Fluted	• TA Tab	• WG-2 Matte Black Grommet - 1 7/8" diameter x 4 1/4" I.D.	100
• MHL Mahogany on Maple	• RD Radius	• FP Side-Routed Finger Pull	• WG-AB Antique Brass Grommet - 2 1/2" diameter I.D.	120
• SMK Smoke on Maple	• RE Reveal		• WG-SN Satin Nickel Grommet - 2 1/2" diameter I.D.	120
	• SQ Square		(see page 10 for location information)	
	• TD Traditional		(see page 11-13 for additional accessories)	
	• TR Transitional			

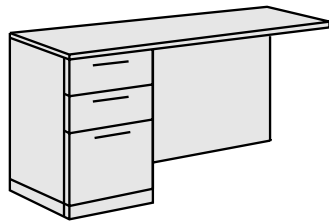

Single Pedestal Return

	Model #	Dimensions	List Price
• Legal width pedestal	PG2042ERB	20" x 42" x 29"H	\$1830
• Box Box File drawers on pedestal	PG2048ERB	20" x 48" x 29"H	1945
• 24"D returns not recommended for use with 60" single pedestal desks	PG2054ERB	20" x 54" x 29"H	2055
• Necessary hardware for attachment included	PG2060ERB	20" x 60" x 29"H	2165
• Must specify left or right from user side	PG2072ERB	20" x 72" x 29"H	2380
	PG2442ERB	24" x 42" x 29"H	1945
	PG2448ERB	24" x 48" x 29"H	2055
	PG2454ERB	24" x 54" x 29"H	2165
	PG2460ERB	24" x 60" x 29"H	2275
	PG2472ERB	24" x 72" x 29"H	2490

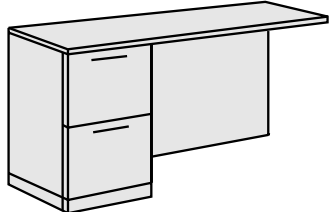

Single Pedestal Return

• Legal width pedestal	PG2042ERF	20" x 42" x 29"H	1830
• File File drawers on pedestal	PG2048ERF	20" x 48" x 29"H	1945
• 24"D returns not recommended for use with 60" single pedestal desks	PG2054ERF	20" x 54" x 29"H	2055
• Necessary hardware for attachment included	PG2060ERF	20" x 60" x 29"H	2165
• Must specify left or right from user side	PG2072ERF	20" x 72" x 29"H	2380
	PG2442ERF	24" x 42" x 29"H	1945
	PG2448ERF	24" x 48" x 29"H	2055
	PG2454ERF	24" x 54" x 29"H	2165
	PG2460ERF	24" x 60" x 29"H	2275
	PG2472ERF	24" x 72" x 29"H	2490

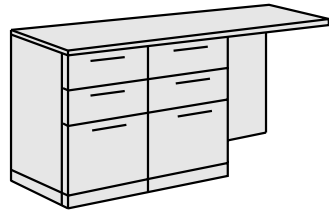

Two Pedestal Return

• Legal width pedestal	PG2048ERBB	20" x 48" x 29"H	2295
• Box Box File drawers on both pedestals	PG2054ERBB	20" x 54" x 29"H	2405
• 24"D returns not recommended for use with 60" single pedestal desks	PG2060ERBB	20" x 60" x 29"H	2510
• Necessary hardware for attachment included	PG2072ERBB	20" x 72" x 29"H	2730
• Must specify left or right from user side	PG2084ERBB	20" x 84" x 29"H	2950
	PG2448ERBB	24" x 48" x 29"H	2405
	PG2454ERBB	24" x 54" x 29"H	2510
	PG2460ERBB	24" x 60" x 29"H	2620
	PG2472ERBB	24" x 72" x 29"H	2840
	PG2484ERBB	24" x 84" x 29"H	3055

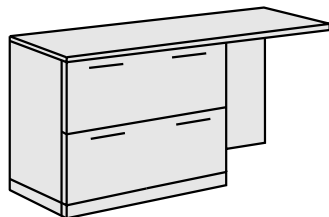

Lateral File Return

• Lateral file pedestal accommodates letter or legal width filing	PG2048ERL	20" x 48" x 29"H	2235
• Anti-tilt safety device	PG2054ERL	20" x 54" x 29"H	2345
• Locks included	PG2060ERL	20" x 60" x 29"H	2455
• 24"D returns not recommended for use with 60" single pedestal desks	PG2072ERL	20" x 72" x 29"H	2680
• Necessary hardware for attachment included	PG2084ERL	20" x 84" x 29"H	2895
• Must specify left or right from user side	PG2448ERL	24" x 48" x 29"H	2345
	PG2454ERL	24" x 54" x 29"H	2455
	PG2460ERL	24" x 60" x 29"H	2565
	PG2472ERL	24" x 72" x 29"H	2785
	PG2484ERL	24" x 84" x 29"H	3005

CORNER UNITS

To specify, include:

- Model Number
- Wood Finish
- Edge Detail
- Hardware Style
- Hardware Finish

Wood Finishes	Edge Details (see p. 5)	Hardware Style (see p. 6 for finishes)	Available Options	List Price
• CML Clear Maple	• AR Arc	• AR Arc	• AK-MP2 Articulating Keyboard Tray	\$470
• COL Clear Oak on Maple	• BV Bevel	• CU Cube	• PK2 Pull-Out Keyboard Tray	395
• AMB Amber on Maple	• CL Classic	• HE Heritage	• WAP Wire Access Panel (full modesty only)	215
• CHY Cherry on Maple	• CV Cove	• OR Orbit	• HM Hinged Modesty	240
• RCL Royal Cherry on Maple	• EL Ellipse	• SW Swoop	• WG-1 Matte Black Grommet - 1 7/8" diameter I.D.	80
• LWL Light Walnut on Maple	• FL Fluted	• TA Tab	• WG-2 Matte Black Grommet - 1 7/8" diameter x 4 1/4" I.D.	100
• ESP Espresso on Maple	• RD Radius	• FP Side-Routed Finger Pull	• WG-AB Antique Brass Grommet - 2 1/2" diameter I.D.	120
• MHL Mahogany on Maple	• RE Reveal		• WG-SN Satin Nickel Grommet - 2 1/2" diameter I.D.	120
• SMK Smoke on Maple	• SQ Square		(see page 10 for location information)	
	• TD Traditional		(see page 11-13 for additional accessories)	
	• TR Transitional			

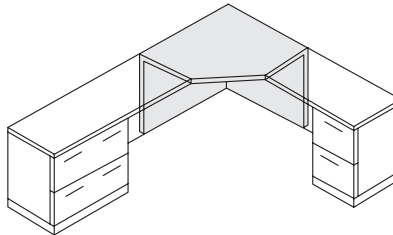
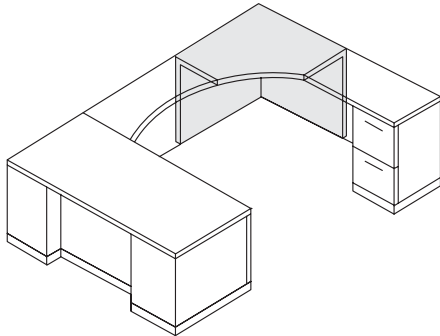

Corner Units must be used in conjunction with Return or Bridge Units. Corner Units with curved working edges may also be joined to Bridges with curved or straight working edges. To ensure proper configurations, please include a diagram with the order.

	Model #	Dimensions	List Price
--	---------	------------	------------

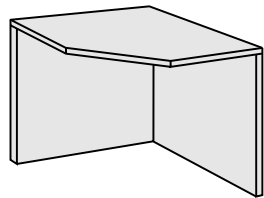

- Accommodates bridge or return units only
- Necessary hardware for attachment included

PG3636CU

36" x 36" x 29"H
22½"W working edge
To accommodate 20" bridge or return

\$1190

PG4242CU

42" x 42" x 29"H
25½"W working edge
To accommodate 24" bridge or return

1405

Corner Unit

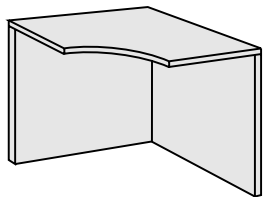

- Accommodates bridge or return units only
- Necessary hardware for attachment included

PG3636CU-C

36" x 36" x 29"H
22½"W working edge
To accommodate 20" bridge or return

1300

PG4242CU-C

42" x 42" x 29"H
25½"W working edge
To accommodate 24" bridge or return

1515

Corner Unit with curved working edge

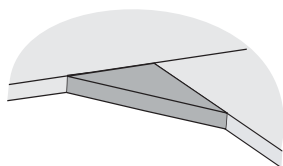

- Fills in square corner to accommodate keyboard tray
- Necessary hardware for attachment included

PG-CTI17

12" x 12" x 17" (user side)

225

PG-CTI26

17" x 17" x 26" (user side)

280

Corner Top Insert

CREDENZAS

Credenzas are available in a variety of preconfigured arrangements or as Modular Credenzas with several filing and storage components to choose from.

All BBF and FF pedestals specified for credenzas are legal width. When specifying credenzas for a U-shaped configuration, always include an open kneespace at the location where the bridge will meet the credenza. An open kneespace is also required to attach Run-Off Desks. All necessary hardware for attachment is included.

Credenzas with a kneespace will accept Articulating and Pull-Out Keyboard Trays, wire management grommets and channels (see pages 10-12 for a complete description and pricing). Optional locks are also available on all credenza pedestals.

Modular Credenzas and Components

Modular Credenzas are reconfigurable in the field, allowing the pedestal positions to be changed for further flexibility. To specify a Modular Credenza, select the components listed on page 38 then specify the unit, left to right. All units are assembled at the factory and shipped as one unit, unless otherwise specified.

When a Modular Credenza is used in a U-shape configuration, an End Panel (**PGSEP**) must be specified with the open kneespace. In addition, a Support Panel (**PGSU**) must be used when there is an open kneespace span of 60" or more. All components and kneespace areas have finished backs. To ensure proper configuration and connecting hardware, a diagram should be included when specifying Modular Credenzas.

Preconfigured Credenzas

Preconfigured Credenzas are available in several variations (see pages 39-41). They are **NOT** reconfigurable in the field.

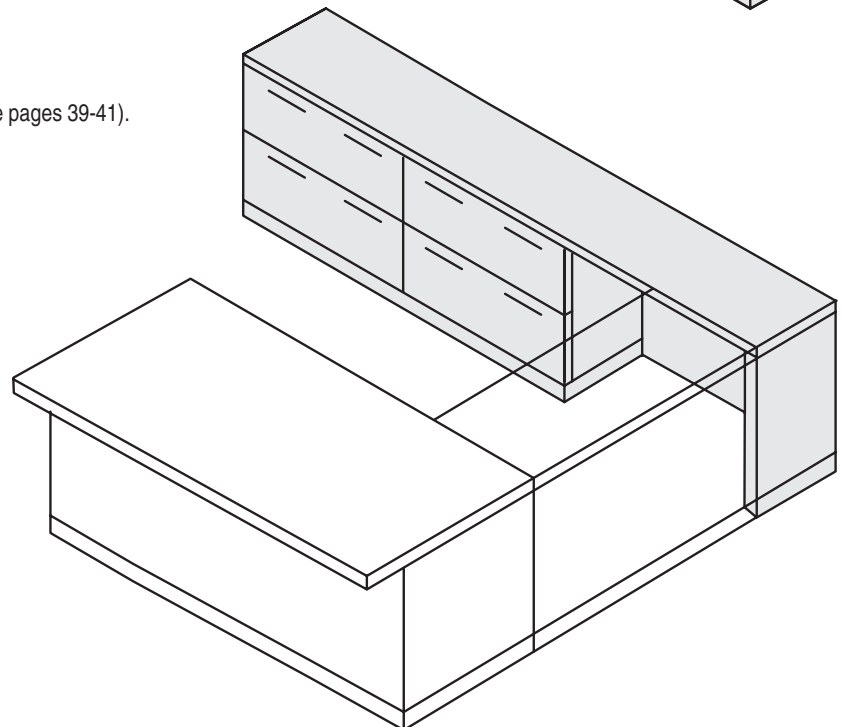
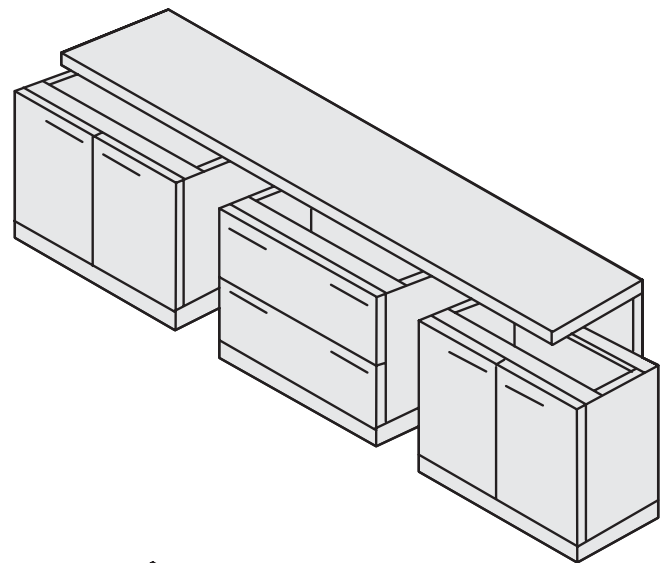
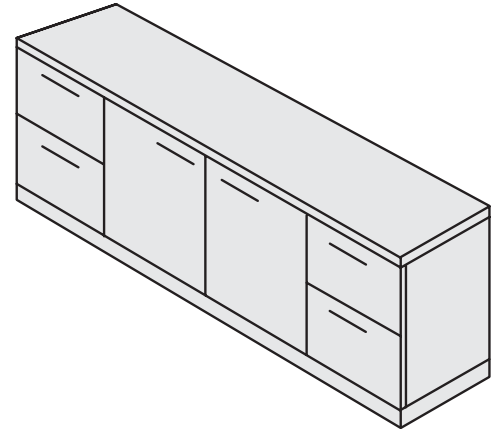

MODULAR CREDENZAS | COMPONENTS

To specify, include:

- Model Number
- Wood Finish
- Edge Detail
- Hardware Style
- Hardware Finish
- List components left to right

Wood Finishes	Edge Details	Hardware Style	Available Options	List Price
<ul style="list-style-type: none"> • CML Clear Maple • COL Clear Oak on Maple • AMB Amber on Maple • CHY Cherry on Maple • RCL Royal Cherry on Maple • LWL Light Walnut on Maple • ESP Espresso on Maple • MHL Mahogany on Maple • SMK Smoke on Maple 	<ul style="list-style-type: none"> (see p. 5) • AR Arc • BV Bevel • CL Classic • CV Cove • EL Ellipse • FL Fluted • RD Radius • RE Reveal • SQ Square • TD Traditional • TR Transitional 	<ul style="list-style-type: none"> (see p. 6 for finishes) • AR Arc • CU Cube • HE Heritage • OR Orbit • SW Swoop • TA Tab • FP Side-Routed Finger Pull 	<ul style="list-style-type: none"> • CD Center Drawer • AK-MP2 Articulating Keyboard Tray • PK2 Pull-Out Keyboard Tray • WAP Wire Access Panel (full modesty only) • HM Hinged Modesty • HD-PTR18 Pull-Out Shelf (for 18" Hinged Door Component) • HD-PTR36 Pull-Out Shelf (for 36" Hinged Door Component) • LK Lock (per pedestal) • WG-1 Matte Black Grommet - 1 7/8" diameter I.D. • WG-2 Matte Black Grommet - 1 7/8" diameter x 4 1/4" I.D. • WG-AB Antique Brass Grommet - 2 1/2" diameter I.D. • WG-SN Satin Nickel Grommet - 2 1/2" diameter I.D. 	<ul style="list-style-type: none"> \$250 470 395 215 240 195 250 80 80 100 120 120

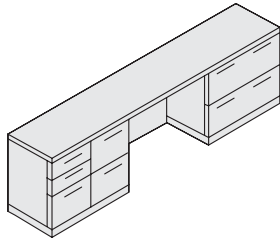

Modular Credenzas are reconfigurable in the field, allowing the pedestal positions to be changed for further flexibility. To specify a Modular Credenza, select from the available worksurfaces, modesties, and components listed below. Credenza components must be specified left to right. All units are assembled at the factory and shipped as one unit, unless otherwise specified. All components and kneespace areas have finished backs. **All BBF and FF pedestals specified for credenzas are legal width.** To ensure proper configuration and connecting hardware, a diagram should be included when specifying Modular Credenzas.

For non-standard length credenzas, refer to the next larger size, then add \$210 to the list price for the cut down charge.

Model #	Dimensions	List Price	Model #	Dimensions	List Price
WORKSURFACE & MODESTY ASSEMBLY:					
PG2036CA	20" x 36" x 29"H	\$1500	PG2436CA	24" x 36" x 29"H	\$1620
PG2048CA	20" x 48" x 29"H	1720	PG2448CA	24" x 48" x 29"H	1840
PG2060CA	20" x 60" x 29"H	1935	PG2460CA	24" x 60" x 29"H	2060
PG2072CA	20" x 72" x 29"H	2160	PG2472CA	24" x 72" x 29"H	2280
PG2078CA	20" x 78" x 29"H	2270	PG2478CA	24" x 78" x 29"H	2385
PG2084CA	20" x 84" x 29"H	2375	PG2484CA	24" x 84" x 29"H	2495
PG2096CA	20" x 96" x 29"H	2595	PG2496CA	24" x 96" x 29"H	2715
PG20102CA	20" x 102" x 29"H	2705	PG24102CA	24" x 102" x 29"H	2825
PG20108CA	20" x 108" x 29"H	2815	PG24108CA	24" x 108" x 29"H	2930

18 1/2" W COMPONENTS:

NOTE: An End Panel (PGSEP) must be specified where an open kneespace is positioned at either end. In addition, a Support Panel (PGSU) must be used when there is an open kneespace span of 60" or more.



PG18BBF
Box/Box/File Drawer

\$460



PG18FF
File/File Drawer

\$460

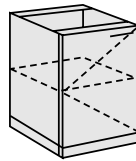

PG18HD
Single Hinged Door
One Adjustable Shelf
(specify hinge right or hinge left)

\$325

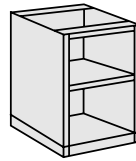

PG18BC
Open Bookcase
One Adjustable Shelf

\$295



PGSEP
End Panel

\$240

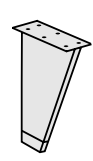

PGSU
Support Panel

\$190

30" | 36" W COMPONENTS:

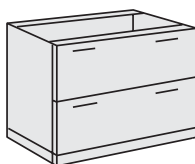

PG30LF
Lateral File
Locks Included
\$650



PG36LF
Lateral File
Locks Included
\$685

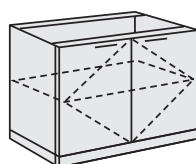

PG36HD
Double Hinged Door
One Adjustable Shelf
\$395

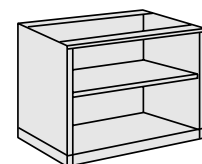

PG36BC
Open Bookcase
One Adjustable Shelf
\$325

PRECONFIGURED CREDENZAS

NOTE: Preconfigured Credenzas are NOT reconfigurable in the field.

To specify, include:

- Model Number
- Wood Finish
- Edge Detail
- Hardware Style
- Hardware Finish

Wood Finishes

- **CML** Clear Maple
- **COL** Clear Oak on Maple
- **AMB** Amber on Maple
- **CHY** Cherry on Maple
- **RCL** Royal Cherry on Maple
- **LWL** Light Walnut on Maple
- **ESP** Espresso on Maple
- **MHL** Mahogany on Maple
- **SMK** Smoke on Maple

Edge Details
(see p. 5)

- **AR** Arc
- **BV** Bevel
- **CL** Classic
- **CV** Cove
- **EL** Ellipse
- **FL** Fluted
- **RD** Radius
- **RE** Reveal
- **SQ** Square
- **TD** Traditional
- **TR** Transitional

Hardware Style
(see p. 6 for finishes)

- **AR** Arc
- **CU** Cube
- **HE** Heritage
- **OR** Orbit
- **SW** Swoop
- **TA** Tab
- **FP** Side-Routed Finger Pull

Available Options

- **CD** Center Drawer \$250
 - **AK-MP2** Articulating Keyboard Tray 470
 - **PK2** Pull-Out Keyboard Tray 395
 - **WAP** Wire Access Panel (full modesty only) 215
 - **HM** Hinged Modesty 240
 - **LK** Lock (per pedestal) 80
 - **WG-1** Matte Black Grommet - 1 7/8" diameter I.D. 80
 - **WG-2** Matte Black Grommet - 1 7/8" diameter x 4 1/4" I.D. 100
 - **WG-AB** Antique Brass Grommet - 2 1/2" diameter I.D. 120
 - **WG-SN** Satin Nickel Grommet - 2 1/2" diameter I.D. 120
- (see page 10 for location information)
(see page 11-13 for additional accessories)

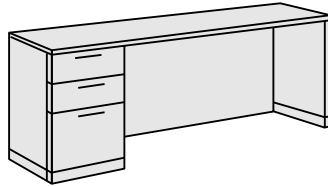

Single Pedestal Credenza

- Legal width pedestal
- Box|Box|File drawers with kneespace
- Optional center drawer
- Necessary hardware for attachment included
- **Must specify left or right facing**

Model #	Dimensions	List Price
PG2072BKS	20" x 72" x 29"H	\$2535
PG2084BKS	20" x 84" x 29"H	2750
PG2472BKS	24" x 72" x 29"H	2640
PG2484BKS	24" x 84" x 29"H	2860

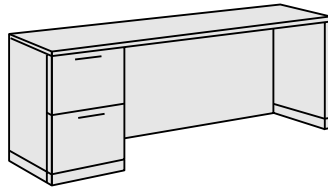

Single Pedestal Credenza

- Legal width pedestal
- File|File drawers with kneespace
- Optional center drawer
- Necessary hardware for attachment included
- **Must specify left or right facing**

PG2072FKS	20" x 72" x 29"H	2535
PG2084FKS	20" x 84" x 29"H	2750
PG2472FKS	24" x 72" x 29"H	2640
PG2484FKS	24" x 84" x 29"H	2860

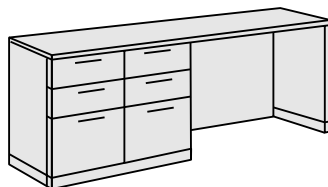

Two Pedestal Credenza

- Legal width pedestal
- Box|Box|File drawers in both pedestals with kneespace
- Optional center drawer
- Necessary hardware for attachment included
- **Must specify left or right facing**

PG2072BBKS	20" x 72" x 29"H	2880
PG2084BBKS	20" x 84" x 29"H	3105
PG2472BBKS	24" x 72" x 29"H	2995
PG2484BBKS	24" x 84" x 29"H	3215

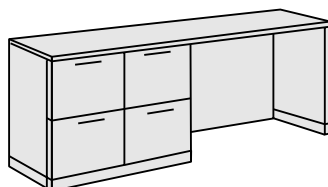

Two Pedestal Credenza

- Legal width pedestal
- File|File drawers in both pedestals with kneespace
- Optional center drawer
- Necessary hardware for attachment included
- **Must specify left or right facing**

PG2072FFKS	20" x 72" x 29"H	2880
PG2084FFKS	20" x 84" x 29"H	3105
PG2472FFKS	24" x 72" x 29"H	2995
PG2484FFKS	24" x 84" x 29"H	3215

PRECONFIGURED CREDENZAS

NOTE: Preconfigured Credenzas are NOT reconfigurable in the field.

To specify, include:

- Model Number
- Wood Finish
- Edge Detail
- Hardware Style
- Hardware Finish

Wood Finishes	Edge Details (see p. 5)	Hardware Style (see p. 6 for finishes)	Available Options	List Price
• CML Clear Maple	• AR Arc	• AR Arc	• CD Center Drawer	\$250
• COL Clear Oak on Maple	• BV Bevel	• CU Cube	• AK-MP2 Articulating Keyboard Tray	470
• AMB Amber on Maple	• CL Classic	• HE Heritage	• PK2 Pull-Out Keyboard Tray	395
• CHY Cherry on Maple	• CV Cove	• OR Orbit	• WAP Wire Access Panel (full modesty only)	215
• RCL Royal Cherry on Maple	• EL Ellipse	• SW Swoop	• HM Hinged Modesty	240
• LWL Light Walnut on Maple	• FL Fluted	• TA Tab	• LK Lock (per pedestal)	80
• ESP Espresso on Maple	• RD Radius	• FP Side-Routed Finger Pull	• WG-1 Matte Black Grommet - 1 7/8" diameter I.D.	80
• MHL Mahogany on Maple	• RE Reveal		• WG-2 Matte Black Grommet - 1 7/8" diameter x 4 1/4" I.D.	100
• SMK Smoke on Maple	• SQ Square		• WG-AB Antique Brass Grommet - 2 1/2" diameter I.D.	120
	• TD Traditional		• WG-SN Satin Nickel Grommet - 2 1/2" diameter I.D.	120
	• TR Transitional		(see page 10 for location information)	
			(see page 11-13 for additional accessories)	

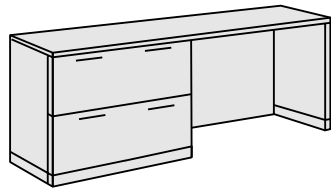

Lateral File Credenza

- Lateral file pedestal accommodates letter or legal width filing
- Anti-tilt safety device
- Lock included
- Necessary hardware for attachment included
- **Must specify left or right facing**

Model #	Dimensions	List Price
PG2072LKS	20" x 72" x 29"H	\$2785
PG2084LKS	20" x 84" x 29"H	3005
PG2472LKS	24" x 72" x 29"H	2895
PG2484LKS	24" x 84" x 29"H	3115

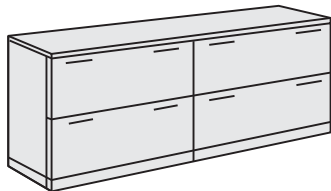

Double Lateral File Credenza

- Lateral file pedestals accommodate letter or legal width filing
- Anti-tilt safety device
- Locks included

PG2072LL	20" x 72" x 29"H	3270
PG2472LL	24" x 72" x 29"H	3380

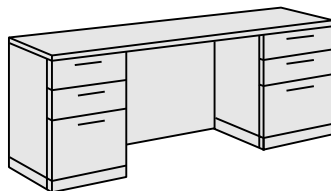

Kneespace Credenza

- Legal width pedestals
- Box|Box|File drawers in both pedestals with center kneespace
- Optional center drawer

PG2072BKSB	20" x 72" x 29"H	2880
PG2084BKSB	20" x 84" x 29"H	3105
PG2472BKSB	24" x 72" x 29"H	2995
PG2484BKSB	24" x 84" x 29"H	3215

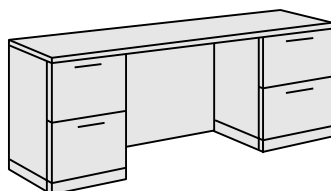

Kneespace Credenza

- Legal width pedestals
- File|File drawers in both pedestals with center kneespace
- Optional center drawer

PG2072FKSF	20" x 72" x 29"H	2880
PG2084FKSF	20" x 84" x 29"H	3105
PG2472FKSF	24" x 72" x 29"H	2995
PG2484FKSF	24" x 84" x 29"H	3215

PRECONFIGURED CREDENZAS

NOTE: Preconfigured Credenzas are NOT reconfigurable in the field.

To specify, include:

- Model Number
- Wood Finish
- Edge Detail
- Hardware Style
- Hardware Finish

Wood Finishes	Edge Details	Hardware Style	Available Options	List Price
<ul style="list-style-type: none"> • CML Clear Maple • COL Clear Oak on Maple • AMB Amber on Maple • CHY Cherry on Maple • RCL Royal Cherry on Maple • LWL Light Walnut on Maple • ESP Espresso on Maple • MHL Mahogany on Maple • SMK Smoke on Maple 	(see p. 5) <ul style="list-style-type: none"> • AR Arc • BV Bevel • CL Classic • CV Cove • EL Ellipse • FL Fluted • RD Radius • RE Reveal • SQ Square • TD Traditional • TR Transitional 	(see p. 6 for finishes) <ul style="list-style-type: none"> • AR Arc • CU Cube • HE Heritage • OR Orbit • SW Swoop • TA Tab • FP Side-Routed Finger Pull 	<ul style="list-style-type: none"> • CD Center Drawer • AK-MP2 Articulating Keyboard Tray • PK2 Pull-Out Keyboard Tray • WAP Wire Access Panel (full modesty only) • HM Hinged Modesty • LK Lock (per pedestal) • WG-1 Matte Black Grommet - 1 7/8" diameter I.D. • WG-2 Matte Black Grommet - 1 7/8" diameter x 4 1/4" I.D. • WG-AB Antique Brass Grommet - 2 1/2" diameter I.D. • WG-SN Satin Nickel Grommet - 2 1/2" diameter I.D. 	<ul style="list-style-type: none"> \$250 470 395 215 240 80 80 100 120 120

	Model #	Dimensions	List Price
 <ul style="list-style-type: none"> • Legal width pedestals • Box Box File drawers in both pedestals at each end • Center hinged door storage with adjustable shelf 	PG2072BHDB	20" x 72" x 29"H	3215
	PG2084BHDB	20" x 84" x 29"H	3430
	PG2472BHDB	24" x 72" x 29"H	3320
	PG2484BHDB	24" x 84" x 29"H	3540

Storage Credenza

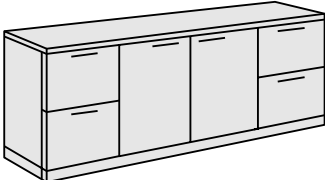
 <ul style="list-style-type: none"> • Legal width pedestals • File File drawers in both pedestals at each end • Center hinged door storage with adjustable shelf 	PG2072FHDF	20" x 72" x 29"H	3215
	PG2084FHDF	20" x 84" x 29"H	3430
	PG2472FHDF	24" x 72" x 29"H	3320
	PG2484FHDF	24" x 84" x 29"H	3540

Storage Credenza

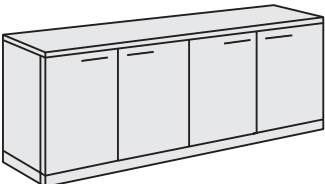
 <ul style="list-style-type: none"> • Hinged door storage • Adjustable shelf • Standard height 	PG2072HDHD	20" x 72" x 29"H	2945
	PG2472HDHD	24" x 72" x 29"H	3050

Storage Credenza

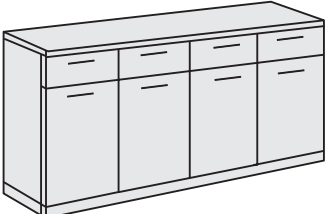
 <ul style="list-style-type: none"> • Four box drawers • Hinged door storage • Adjustable shelf • Buffet height (36"H) 	PG2072HDHD-BH	20" x 72" x 36"H	3815
	PG2472HDHD-BH	24" x 72" x 36"H	3925

Buffet Serving | Storage Credenza

OVERHEAD STORAGE | TOP UNITS

Top Units provide overhead storage behind hinged doors. Units rest on top of any Credenza of corresponding length or may span over several units (i.e., desk, bridge, and corner unit in U-shape configuration).

Top Units are available in several lengths to accommodate most combinations of lower unit sizes. All Top Units include European-style, self-closing hinges for each door that are fully adjustable for proper door alignment. Top Units are also available without the doors for open storage, please specify. All units ship fully assembled from the factory.

Additional storage can be achieved through the specification of Top Units with paper management shelves ("TPM" version) and/or the incorporation of Paper Management Organizers.

Paper Management Organizers are permanently mounted into Top Units. They are offered with several storage options and two sizes (one size to fit under a regular Top Unit and another size to fit under the "TPM" Top Unit version). Storage options include: open shelving, letter tray drawers, and CD storage drawers. Please specify right or left position when ordering a single organizer. **Two organizers will automatically be positioned at each end, unless otherwise specified.**

Top Units are also available with optional Acoustical Tack Panels and Accessory Walls. Tack Panels are covered in a specified fabric and Accessory Walls consist of an extruded, black, plastic slatwall. When used in conjunction with Organizing Elements, Accessory Walls provide added workspace through paper management and easy-to-access storage for desktop items (see Workspace Accessories on page 13 for complete information and pricing on Tack Panels and Accessory Walls).

Optional locks are available on all hinged doors. In addition, a valance below the hinged doors enables the placement of an optional Task Light (see Workspace Accessories on page 12 for complete information and pricing).

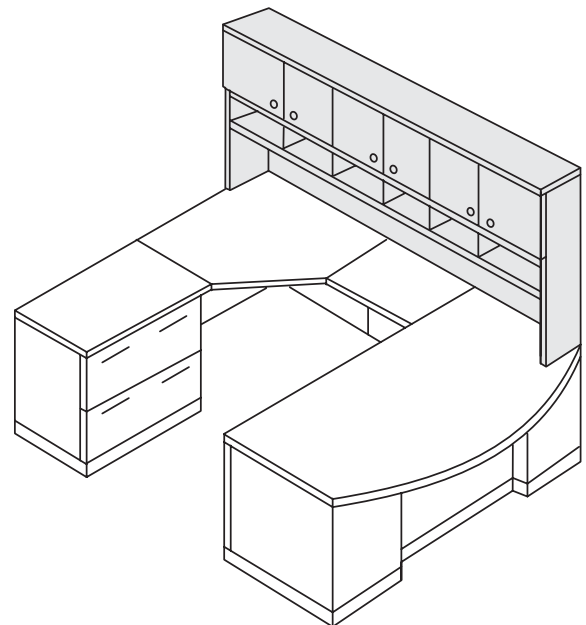
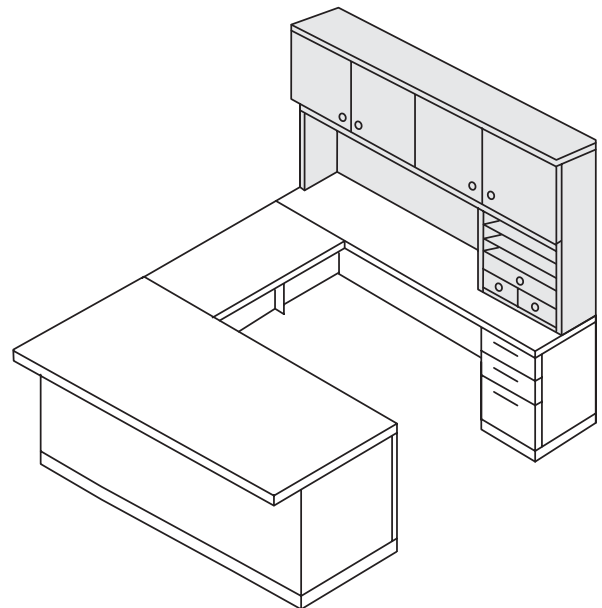
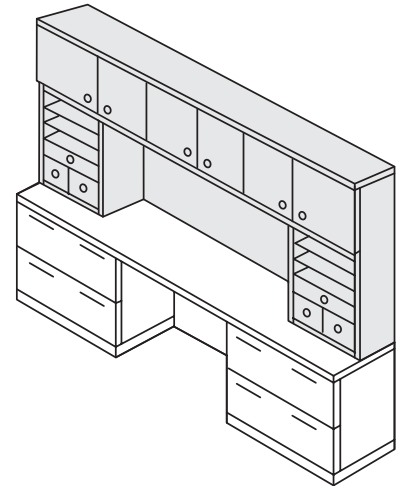

WORKWALLS AND STORAGE | OVERVIEW

Multiple storage units may be combined to form continuous workwalls. These workwalls may function in the rear of a U-shape configuration, on the side with a Run-Off Desk, or as a "stand-alone" workwall for auxiliary storage.

Paull Group offers several component options to create the specific built-in appearance. They include: End-Run Bookcases, single and full size Storage Units, Top Units, Credenzas, Pediments, and Paper Management Organizers. Each component is available in several different sizes, pedestal options, and styles, resulting in endless workwall possibilities.

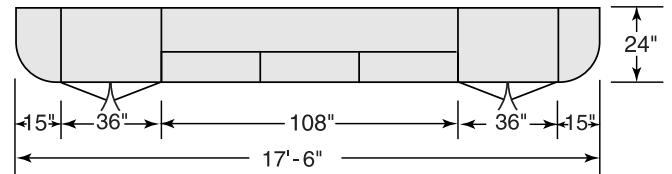
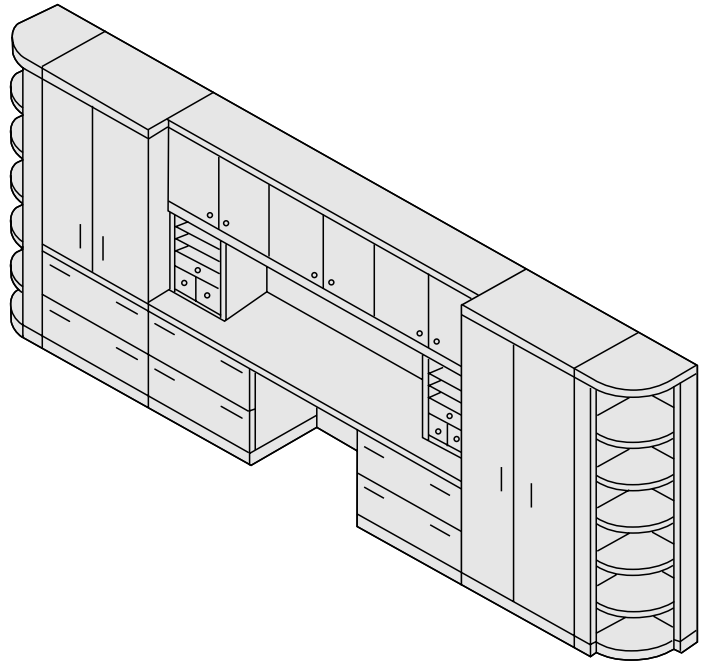

WORKWALLS AND STORAGE | DOOR OPTIONS

Standard doors on Top Units and Storage Units are a flat, wood panel. Wood-framed doors with frosted glass, as well as aluminum-framed doors with frosted glass are also available.

Storage Units and Storage Towers are available with optional glass shelves when using either the frosted glass door option. Optional interior cabinet lighting is available for overhead storage units specified with glass doors. Glass shelves are recommended when using interior cabinet lighting.

Pricing for optional glass doors, glass shelves, and interior cabinet lighting can be found on product pages 45-48.

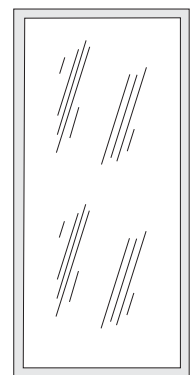
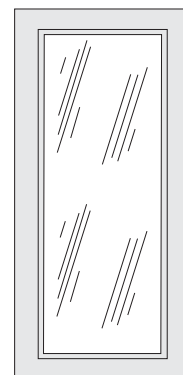
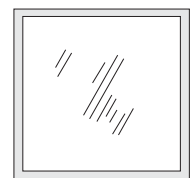
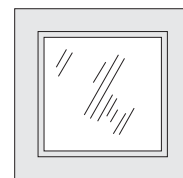

Wood-Framed Doors with Frosted Glass

Aluminum-Framed Doors with Frosted Glass

WORKWALLS AND STORAGE | PEDIMENTS & END-RUN BOOKCASES

The overall style of a workwall can be enhanced with the addition of Pediments and End-Run Bookcases. Pediments are available in two styles, Gabled and Arched, and may be used with any Top Unit or 36"W Storage Unit.

End-Run Bookcases can be positioned at either or both ends of a workwall. They are offered in two styles: Square and Quarter Round. End-Run Bookcases are designed to be placed flush against 72"H components with corresponding **depths**. All bookcases include heavy duty 1" shelves.

To specify for flush placement of End-Run Bookcases, select the appropriate bookcase according to depth. For example, if an End-Run Bookcase is positioned next to a 24"D Storage Unit, then 24"D bookcase should be specified. Or, if an End-Run Bookcase is positioned next to a 15"D Top Unit, then a 15"D bookcase should be specified. In addition, please indicate left (-LEFT) or right (-RIGHT) position.

Quarter-Round End-Run Bookcases are also available in a 29"H version for flush placement against other 29"H units (i.e., desks, returns, and credenzas).

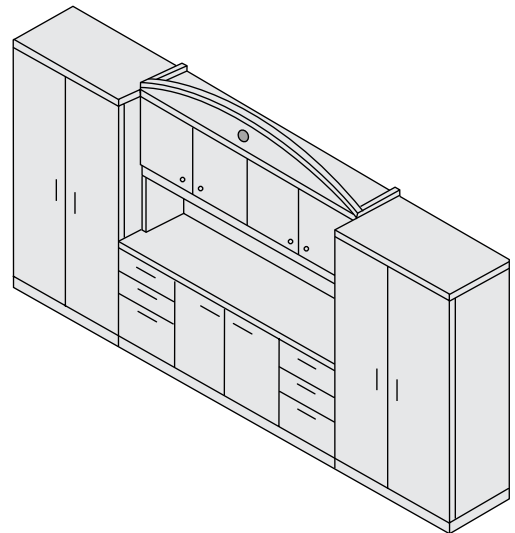
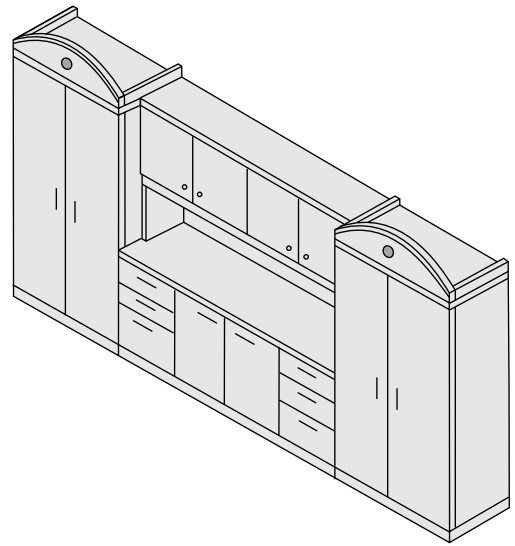

NOTE: A kneespace credenza must be specified to incorporate a workwall into a U-shape or side wall configuration.

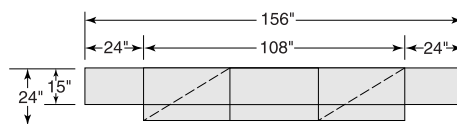
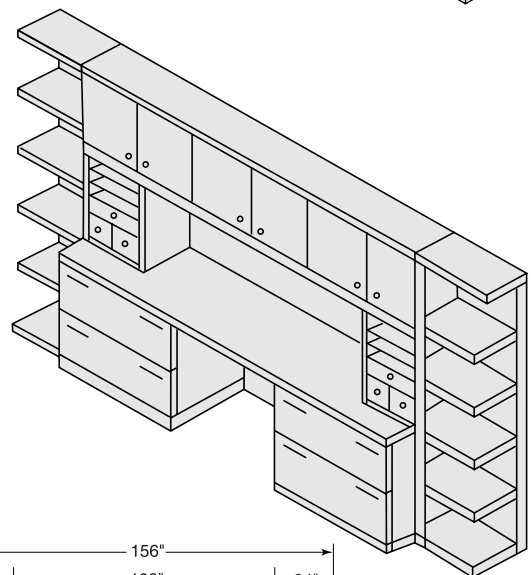
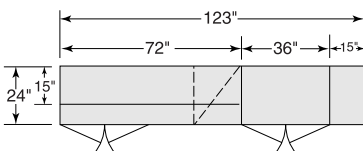
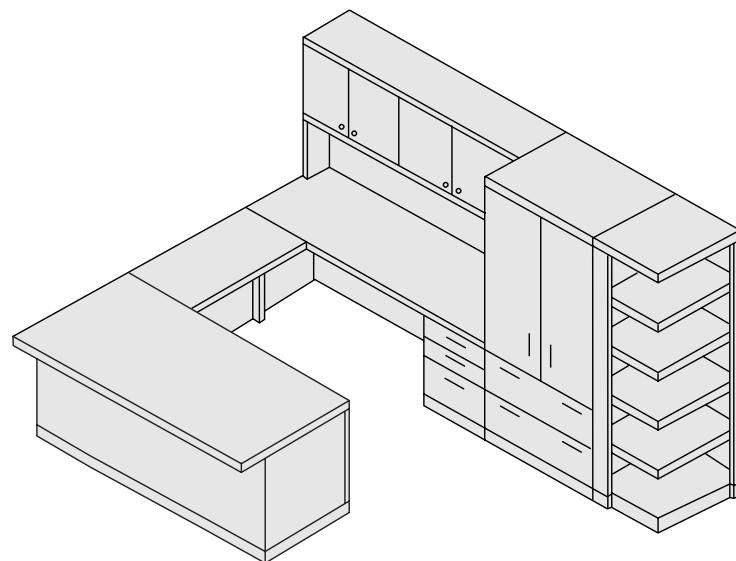

OVERHEAD STORAGE | TOP UNITS (15"D)

*NOTE: Pricing for Tack Panels is based on the standard fabric (Maharam, Messenger-Balsa) or COM. Accessory Walls also may be used in lieu of Tack Panels. See page 13 for more information.

To specify, include:

- Model Number
- Wood Finish
- Edge Detail
- Hardware Style
- Hardware Finish

Wood Finishes	Edge Details	Hardware Style	Available Options	List Price
<ul style="list-style-type: none"> • CML Clear Maple • COL Clear Oak on Maple • AMB Amber on Maple • CHY Cherry on Maple • RCL Royal Cherry on Maple • LWL Light Walnut on Maple • ESP Espresso on Maple • MHL Mahogany on Maple • SMK Smoke on Maple 	<ul style="list-style-type: none"> (see p. 5) • AR Arc • BV Bevel • CL Classic • CV Cove • EL Ellipse • FL Fluted • RD Radius • RE Reveal • SQ Square • TD Traditional • TR Transitional 	<ul style="list-style-type: none"> (see p. 6 for finishes) • AR Arc • CU Cube • HE Heritage • OR Orbit • SW Swoop • TA Tab • FP Side-Routed Finger Pull 	<ul style="list-style-type: none"> • LK Lock (per pedestal) \$80 • ICL Interior Cabinet Lighting (priced each) 125 • TL-27 27½ Task Light 175 • TL-57 57½ Task Light 315 • WG-1 Grommet for task light - 1 7/8" diameter I.D. 80 	<ul style="list-style-type: none"> Messenger-Balsa COM • TP-36 36"W Fabric Tack Panel* 355 • TP-72 72"W Fabric Tack Panel* 465 • TP-78 78"W Fabric Tack Panel* 485 • TP-84 84"W Fabric Tack Panel* 500 • TP-92 92"W Fabric Tack Panel* 520 • TP-96 96"W Fabric Tack Panel* 540 • TP-102 102"W Fabric Tack Panel* 560 • TP-108 108"W Fabric Tack Panel* 585

	Model #	Dimensions	List Price
--	---------	------------	------------

<ul style="list-style-type: none"> • Includes two adjustable shelves 	PG15360	15" x 36" x 43"H	\$1585
---	----------------	------------------	--------

Top Unit, open shelves

<ul style="list-style-type: none"> • One pair of hinged doors with one adjustable shelf • Standard wood doors • Optional frosted glass doors framed in either wood or aluminum • 24½"H clearance below valance • Optional tack panel or accessory wall • Optional task light • Grommet must be specified with optional task light 	PG1536T	15" x 36" x 43"H	1690
	INSET-GL	Wood-framed frosted glass doors	+350
	INSET-AGL	Aluminum-framed frosted glass doors	+495

Top Unit, hinged door storage

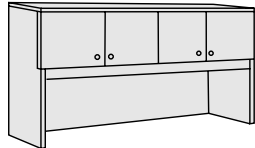
<ul style="list-style-type: none"> • Two pair of hinged doors • Standard wood doors • Optional frosted glass doors framed in either wood or aluminum • Available without doors • 24½"H clearance below valance • Optional tack panel or accessory wall • Optional task light • Grommet must be specified with optional task light 	PG1572T	15" x 72" x 43"H	2840
	PG1578T	15" x 78" x 43"H	3005
	PG1584T	15" x 84" x 43"H	3165
	INSET-GL	Wood-framed frosted glass doors	+730
	INSET-AGL	Aluminum-framed frosted glass doors	+1075
	Available without doors, please specify and deduct \$200 from the list price.		

Top Unit, hinged door storage

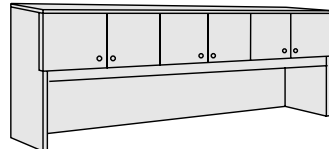
<ul style="list-style-type: none"> • Three pair of hinged doors • Standard wood doors • Optional frosted glass doors framed in either wood or aluminum • Available without doors • 24½"H clearance below valance • Optional tack panel or accessory wall • Optional task light • Grommet must be specified with optional task light 	PG1592T	15" x 92" x 43"H	3495
	PG1596T	15" x 96" x 43"H	3660
	PG15102T	15" x 102" x 43"H	3820
	INSET-GL	Wood-framed frosted glass doors	+1110
	INSET-AGL	Aluminum-framed frosted glass doors	+1525
	Available without doors, please specify and deduct \$300 from the list price.		

Top Unit, hinged door storage

OVERHEAD STORAGE | TOP UNITS (15"D)

*NOTE: Pricing for Tack Panels is based on the standard fabric (Maharam, Messenger-Balsa) or COM. Accessory Walls also may be used in lieu of Tack Panels. See page 13 for more information.

- To specify, include:**
- Model Number
 - Wood Finish
 - Edge Detail
 - Hardware Style
 - Hardware Finish

Wood Finishes	Edge Details	Hardware Style	Available Options	List Price
• CML Clear Maple	(see p. 5)	(see p. 6 for finishes)	• LK Lock (per pedestal)	\$80
• COL Clear Oak on Maple	• AR Arc	• AR Arc	• ICL Interior Cabinet Lighting (priced each)	125
• AMB Amber on Maple	• BV Bevel	• CU Cube	• TL-27 27½ Task Light	175
• CHY Cherry on Maple	• CL Classic	• HE Heritage	• TL-57 57½ Task Light	315
• RCL Royal Cherry on Maple	• CV Cove	• OR Orbit	• WG-1 Grommet for task light - 1 7/8" diameter I.D.	80
• LWL Light Walnut on Maple	• EL Ellipse	• SW Swoop	Messenger-Balsa	COM
• ESP Espresso on Maple	• FL Fluted	• TA Tab	• TP-36 36"W Fabric Tack Panel*	355
• MHL Mahogany on Maple	• RD Radius	• FP Side-Routed Finger Pull	• TP-72 72"W Fabric Tack Panel*	465
• SMK Smoke on Maple	• RE Reveal		• TP-78 78"W Fabric Tack Panel*	485
	• SQ Square		• TP-84 84"W Fabric Tack Panel*	500
	• TD Traditional		• TP-92 92"W Fabric Tack Panel*	520
	• TR Transitional		• TP-96 96"W Fabric Tack Panel*	540
			• TP-102 102"W Fabric Tack Panel*	560
			• TP-108 108"W Fabric Tack Panel*	585

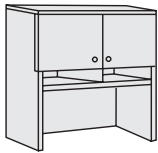

Top Unit, hinged door storage with paper management shelf

- One pair of hinged doors
- Standard wood doors
- Optional frosted glass doors framed in either wood or aluminum
- 18¾"H clearance below valance
- Optional tack panel or accessory wall
- Optional task light
- Grommet must be specified with optional task light

Model #	Dimensions	List Price
PG1536TPM	15" x 36" x 43"H	\$1815
INSET-GL	Wood-framed frosted glass doors	+350
INSET-AGL	Aluminum-framed frosted glass doors	+495

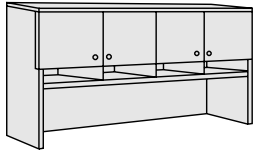

Top Unit, hinged door storage with paper management shelf

- Two pair of hinged doors
- Standard wood doors
- Optional frosted glass doors framed in either wood or aluminum
- Available without doors
- 18¾"H clearance below valance
- Optional tack panel or accessory wall
- Optional task light
- Grommet must be specified with optional task light

PG1572TPM	15" x 72" x 43"H	3060
PG1578TPM	15" x 78" x 43"H	3230
PG1584TPM	15" x 84" x 43"H	3395
INSET-GL	Wood-framed frosted glass doors	+730
INSET-AGL	Aluminum-framed frosted glass doors	+1075

Available without doors, please specify and deduct **\$200** from the list price.

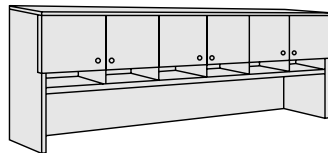

Top Unit, hinged door storage with paper management shelf

- Three pair of hinged doors
- Standard wood doors
- Optional frosted glass doors framed in either wood or aluminum
- Available without doors
- 18¾"H clearance below valance
- Optional tack panel or accessory wall
- Optional task light
- Grommet must be specified with optional task light

PG1592TPM	15" x 92" x 43"H	3845
PG1596TPM	15" x 96" x 43"H	4020
PG15102TPM	15" x 102" x 43"H	4185
PG15108TPM	15" x 108" x 43"H	4350
INSET-GL	Wood-framed frosted glass doors	+1110
INSET-AGL	Aluminum-framed frosted glass doors	+1525

Available without doors, please specify and deduct **\$300** from the list price.

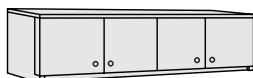
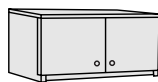

Wall Mount, hinged door storage

- Standard wood doors
- Optional frosted glass doors framed in either wood or aluminum
- French cleat mounting strip included
- Optional task light

PG30WM	15¾" x 30" x 19"H (2 doors)	1255
INSET-GL	Wood-framed frosted glass doors	+350
INSET-AGL	Not Available	N/A
PG36WM	15¾" x 36" x 19"H (2 doors)	1315
INSET-GL	Wood-framed frosted glass doors	+350
INSET-AGL	Aluminum-framed frosted glass doors	+495
PG48WM	15¾" x 48" x 19"H (3 doors)	1530
INSET-GL	Wood-framed frosted glass doors	+475
INSET-AGL	Aluminum-framed frosted glass doors	+745
PG72WM	15¾" x 72" x 19"H (4 doors)	2405
INSET-GL	Wood-framed frosted glass doors	+700
INSET-AGL	Aluminum-framed frosted glass doors	+990

PEDIMENTS | PAPER MANAGEMENT ORGANIZERS

To specify, include:

- Model Number
- Wood Finish
- Hardware Style
- Hardware Finish

Wood Finishes

- **CML** Clear Maple
- **COL** Clear Oak on Maple
- **AMB** Amber on Maple
- **CHY** Cherry on Maple
- **RCL** Royal Cherry on Maple
- **LWL** Light Walnut on Maple
- **ESP** Espresso on Maple
- **MHL** Mahogany on Maple
- **SMK** Smoke on Maple

Edge Details

- (see p. 5)
- **AR** Arc
 - **BV** Bevel
 - **CL** Classic
 - **CV** Cove
 - **EL** Ellipse
 - **FL** Fluted
 - **RD** Radius
 - **RE** Reveal
 - **SQ** Square
 - **TD** Traditional
 - **TR** Transitional

Hardware Style

- (see p. 6 for finishes)
- **AR** Arc
 - **CU** Cube
 - **HE** Heritage
 - **OR** Orbit
 - **SW** Swoop
 - **TA** Tab
 - **FP** Side-Routed Finger Pull

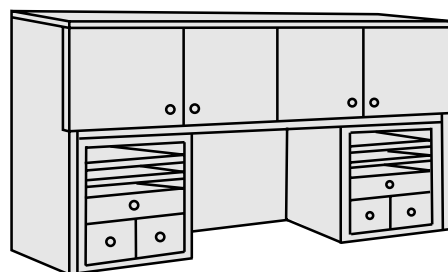

The appearance of Top Units can be altered with the addition of Pediments and Paper Management Organizers. Pediments are available in two styles, Gabled and Arched, and may be used with any Top Unit or 36"W Storage Unit. Paper Management Organizers are permanently mounted into Top Units. Please specify right or left position when ordering a single organizer. Two organizers will automatically be positioned at each end, unless otherwise specified.

	Model #	Dimensions	List Price
Gabled Top Unit Pediment:			
	PG-GPED36	36" x 15"D	\$325
	PG-GPED72	72" x 15"D	435
	PG-GPED78	78" x 15"D	460
	PG-GPED84	84" x 15"D	495
	PG-GPED36-24	36" x 24"D	410
Arched Top Unit Pediment:			
	PG-APED36	36" x 15"D	355
	PG-APED72	72" x 15"D	460
	PG-APED78	78" x 15"D	495
	PG-APED84	84" x 15"D	520
	PG-APED36-24	36" x 24"D	435

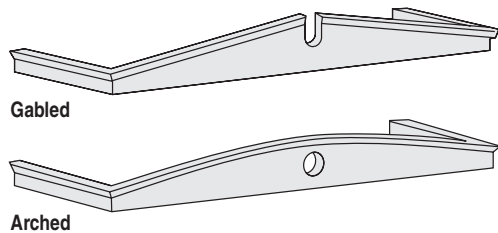

Pediments, Gabled and Arched, to be used with any Top Unit or 36" wide Storage Unit.

	PG-PMO5-1	17¼" x 13¼" x 25"H 3 Open Shelves 1 Letter Tray Drawer 2 CD Storage Drawers	515
	PG-PMO5-2	17¼" x 13¼" x 25"H 2 Open Shelves 2 Letter Tray Drawers 2 CD Storage Drawers	535
	PG-PMO5-3	17¼" x 13¼" x 25"H 5 Open Shelves	460

Paper Management Organizer for use with Top Units **without** the paper management shelf ("T" version).

	PG-PMO4-1	17¼" x 13¼" x 19¼"H 2 Open Shelves 1 Letter Tray Drawer 2 CD Storage Drawers	465
	PG-PMO4-2	17¼" x 13¼" x 19¼"H 4 Open Shelves	410

Paper Management Organizer for use with Top Units **with** the paper management shelf ("TPM" version).

STORAGE

Wood Finishes	Edge Details	Hardware Style	Available Options	List Price
<ul style="list-style-type: none"> CML Clear Maple COL Clear Oak on Maple AMB Amber on Maple CHY Cherry on Maple RCL Royal Cherry on Maple LWL Light Walnut on Maple ESP Espresso on Maple MHL Mahogany on Maple SMK Smoke on Maple 	(see p. 5) <ul style="list-style-type: none"> AR Arc BV Bevel CL Classic CV Cove EL Ellipse FL Fluted RD Radius RE Reveal SQ Square TD Traditional TR Transitional 	(see p. 6 for finishes) <ul style="list-style-type: none"> AR Arc CU Cube HE Heritage OR Orbit SW Swoop TA Tab FP Side-Routed Finger Pull 	<ul style="list-style-type: none"> LK Lock ICL Interior Cabinet Lighting (priced each) WG-1 Matte Black Grommet - 1 7/8" diameter I.D. WG-2 Matte Black Grommet - 1 7/8" diameter x 4 1/4" I.D. WG-AB Antique Brass Grommet - 2 1/2" diameter I.D. WG-SN Satin Nickel Grommet - 2 1/2" diameter I.D. 	<ul style="list-style-type: none"> \$80 125 80 100 120 120

To specify, include:

- Model Number
- Wood Finish
- Edge Detail
- Hardware Style
- Hardware Finish

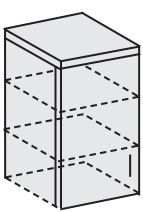

Single Hinged Door Storage Tower

- Single hinged door
- Standard wood door
- Optional frosted glass doors framed in either wood or aluminum
- Two adjustable shelves
- Optional glass shelves
- **Must specify hinge left or right**

Model #	Dimensions	List Price
PG1518S	15" x 18" x 43"H	\$1490
INSET-GL	Wood-framed frosted glass doors	+325
INSET-AGL	Aluminum-framed frosted glass doors	+495
GLS	Two Glass Shelves	+65

Available without doors, please specify and deduct **\$200** from the list price.

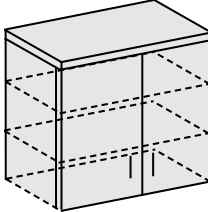

Hinged Door Storage Tower

- One pair of hinged doors
- Standard wood doors
- Optional frosted glass doors framed in either wood or aluminum
- Two adjustable shelves
- Optional glass shelves

PG1536S	15" x 36" x 43"H	2080
INSET-GL	Wood-framed frosted glass doors	+635
INSET-AGL	Aluminum-framed frosted glass doors	+975
GLS	Two Glass Shelves	+135

Available without doors, please specify and deduct **\$400** from the list price.

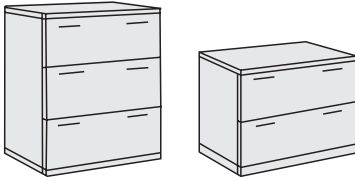

Three and Two Drawer Lateral File

- Accommodates letter or legal width filing
- Anti-tilt safety device
- Locks included

Two Drawer Lateral File		
PG2036L	20" x 36" x 29"H	1815
PG2436L	24" x 36" x 29"H	1925
Three Drawer Lateral File		
PG2036-3L	20" x 36" x 42"H	2650
PG2436-3L	24" x 36" x 42"H	2785

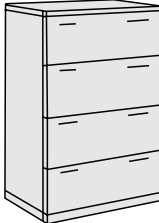

Four Drawer Lateral File

- Accommodates letter or legal width filing
- Anti-tilt safety device
- Locks included

PG2036-4L	20" x 36" x 54"H	3225
PG2436-4L	24" x 36" x 54"H	3330

STORAGE

Wood Finishes	Edge Details	Hardware Style	Available Options	List Price
<ul style="list-style-type: none"> CML Clear Maple COL Clear Oak on Maple AMB Amber on Maple CHY Cherry on Maple RCL Royal Cherry on Maple LWL Light Walnut on Maple ESP Espresso on Maple MHL Mahogany on Maple SMK Smoke on Maple 	(see p. 5) <ul style="list-style-type: none"> AR Arc BV Bevel CL Classic CV Cove EL Ellipse FL Fluted RD Radius RE Reveal SQ Square TD Traditional TR Transitional 	(see p. 6 for finishes) <ul style="list-style-type: none"> AR Arc CU Cube HE Heritage OR Orbit SW Swoop TA Tab FP Side-Routed Finger Pull 	<ul style="list-style-type: none"> LK Lock (per pair hinged doors) \$80 WG-1 Matte Black Grommet - 1 7/8" diameter I.D. 80 WG-2 Matte Black Grommet - 1 7/8" diameter x 4 1/4" I.D. 100 WG-AB Antique Brass Grommet - 2 1/2" diameter I.D. 120 WG-SN Satin Nickel Grommet - 2 1/2" diameter I.D. 120 	

- To specify, include:**
- Model Number
 - Wood Finish
 - Edge Detail
 - Hardware Style
 - Hardware Finish

	Model #	Dimensions	List Price
--	---------	------------	------------

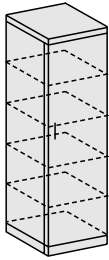

- Single hinged door
- Standard, full height wood door
- One fixed shelf, three adjustable shelves
- **Must specify hinge left or right**

PG2424FS 24" x 24" x 72"H \$2565

Full Height Single Storage Unit

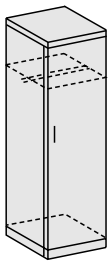

- Single hinged door
- Standard, full height wood door
- One fixed shelf
- Clothes pole
- **Must specify hinge left or right**

PG2424WS 24" x 24" x 72"H 2455

Full Height Single Wardrobe Storage Unit

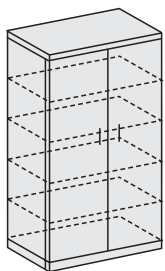

- One pair of hinged doors
- Standard, full height wood doors
- One fixed shelf, three adjustable shelves

PG2436FS 24" x 36" x 72"H 4095

Full Height Storage Unit

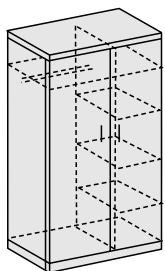

- One pair of hinged doors
- Standard, full height wood doors
- One fixed shelf, full width
- Side-by-side storage, clothespole in left section, three adjustable shelves in right section

PG2436WS 24" x 36" x 72"H 3995

Full Height Wardrobe Storage Unit

STORAGE

Wood Finishes	Edge Details	Hardware Style	Available Options	List Price
<ul style="list-style-type: none"> CML Clear Maple COL Clear Oak on Maple AMB Amber on Maple CHY Cherry on Maple RCL Royal Cherry on Maple LWL Light Walnut on Maple ESP Espresso on Maple MHL Mahogany on Maple SMK Smoke on Maple 	(see p. 5) <ul style="list-style-type: none"> AR Arc BV Bevel CL Classic CV Cove EL Ellipse FL Fluted RD Radius RE Reveal SQ Square TD Traditional TR Transitional 	(see p. 6 for finishes) <ul style="list-style-type: none"> AR Arc CU Cube HE Heritage OR Orbit SW Swoop TA Tab FP Side-Routed Finger Pull 	<ul style="list-style-type: none"> LK Lock (per pair hinged doors) \$80 ICL Interior Cabinet Lighting (priced each) 125 WG-1 Matte Black Grommet - 1 7/8" diameter I.D. 80 WG-2 Matte Black Grommet - 1 7/8" diameter x 4 1/4" I.D. 100 WG-AB Antique Brass Grommet - 2 1/2" diameter I.D. 120 WG-SN Satin Nickel Grommet - 2 1/2" diameter I.D. 120 	

- To specify, include:**
- Model Number
 - Wood Finish
 - Edge Detail
 - Hardware Style
 - Hardware Finish

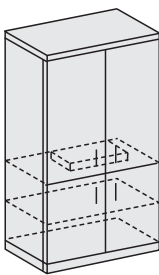

Full Height Media and AV Storage Unit

- Two pair of hinged doors
- Standard wood doors
- Upper storage section includes retractable hinged doors, space for DVD player & monitor*
- Lower storage section includes one adjustable shelf
- Wire access grommets standard

Model #	Dimensions	List Price
PG2436AV	24" x 36" x 72"H	\$4640
	*Monitor space I.D. approximately 19-7/8D x 29 1/4W x 31 1/2H	

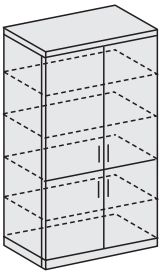

Full Height Hinged Door Storage Unit

- Two pair of hinged doors
- Standard wood doors
- Upper doors available with optional frosted glass framed in either wood or aluminum doors with frosted glass
- Upper storage section includes two adjustable shelves
- Lower storage section includes one adjustable shelf
- Optional glass shelves for upper storage section

PG2436HDS	24" x 36" x 72"H	4255
INSET-GL	Wood-framed frosted glass doors	+635
INSET-AGL	Aluminum-framed frosted glass doors	+975
GLS	Two Glass Shelves	+135

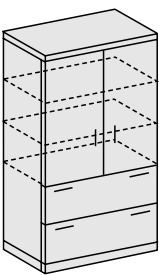

Full Height Two Drawer Lateral File Storage Unit

- Upper storage section includes two adjustable shelves behind one pair of hinged doors
- Standard wood doors
- Optional frosted glass doors framed in either wood or aluminum
- Optional glass shelves
- Lower storage section includes two lateral files, accommodates letter or legal width filing
- Locks and anti-tilt device included on lateral files

PG2436LFS	24" x 36" x 72"H	4365
INSET-GL	Wood-framed frosted glass doors	+635
INSET-AGL	Aluminum-framed frosted glass doors	+975
GLS	Two Glass Shelves	+135

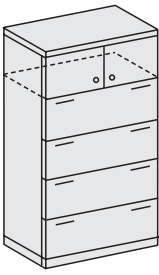

Full Height Four Drawer Lateral File Storage Unit

- Upper storage section includes one pair of hinged doors
- Lower storage section includes four lateral files, accommodates letter or legal width filing
- Locks and anti-tilt device included on lateral files

PG2436LLS	24" x 36" x 72"H	4750
------------------	------------------	------

END-RUN BOOKCASES

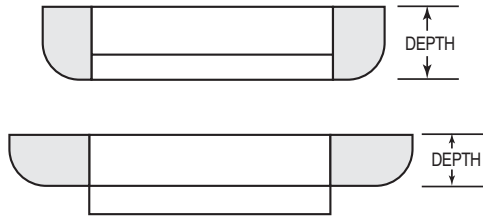

To specify, include:

- Model Number
- Wood Finish
- Edge Detail

Wood Finishes

- **CML** Clear Maple
- **COL** Clear Oak on Maple
- **AMB** Amber on Maple
- **CHY** Cherry on Maple
- **RCL** Royal Cherry on Maple
- **LWL** Light Walnut on Maple
- **ESP** Espresso on Maple
- **MHL** Mahogany on Maple
- **SMK** Smoke on Maple

Edge Details

- (see p. 5)
- **AR** Arc
 - **BV** Bevel
 - **CL** Classic
 - **CV** Cove
 - **EL** Ellipse
 - **FL** Fluted
 - **RD** Radius
 - **RE** Reveal
 - **SQ** Square
 - **TD** Traditional
 - **TR** Transitional

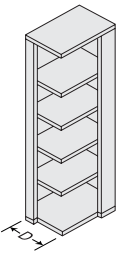
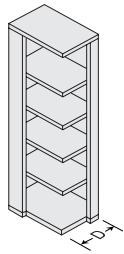
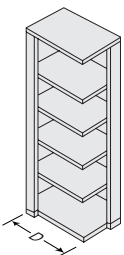
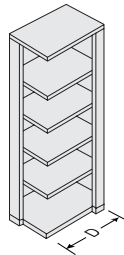
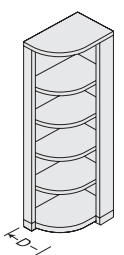
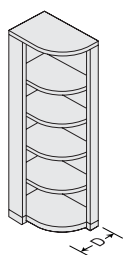
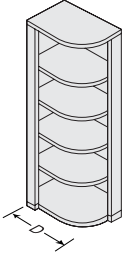
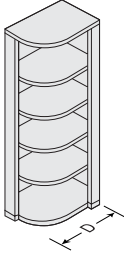
		Model #	Dimensions	List Price	
 Square End-Run Bookcase-LEFT	 Square End-Run Bookcase-RIGHT	<ul style="list-style-type: none"> • Four adjustable shelves • Heavy duty 1" shelves • To be used adjacent to units with corresponding depth (i.e., Storage Units are 24"D and Top Units are 15"D) • Must specify -LEFT or -RIGHT 	PGSBC1520	15"D x 20"W x 72"H	\$1860
			PGSBC1524	15"D x 24"W x 72"H	1910
 Square End-Run Bookcase-LEFT	 Square End-Run Bookcase-RIGHT	<ul style="list-style-type: none"> • Four adjustable shelves • Heavy duty 1" shelves • To be used adjacent to units with corresponding depth (i.e., Storage Units are 24"D and Top Units are 15"D) • Must specify -LEFT or -RIGHT 	PGSBC2015	20"D x 15"W x 72"H	1860
			PGSBC2415	24"D x 15"W x 72"H	1910
 Quarter Round End-Run Bookcase-LEFT	 Quarter Round End-Run Bookcase-RIGHT	<ul style="list-style-type: none"> • Four adjustable shelves • Heavy duty 1" shelves • To be used adjacent to units with corresponding depth (i.e., Storage Units are 24"D and Top Units are 15"D) • Must specify -LEFT or -RIGHT 	PGQBC1520	15"D x 20"W x 72"H	1995
			PGQBC1524	15"D x 24"W x 72"H	2080
 Quarter Round End-Run Bookcase-LEFT	 Quarter Round End-Run Bookcase-RIGHT	<ul style="list-style-type: none"> • Four adjustable shelves • Heavy duty 1" shelves • To be used adjacent to units with corresponding depth (i.e., Storage Units are 24"D and Top Units are 15"D) • Must specify -LEFT or -RIGHT 	PGQBC2015	20"D x 15"W x 72"H	1995
			PGQBC2415	24"D x 15"W x 72"H	2080

BOOKCASES

Wood Finishes

- **CML** Clear Maple
- **COL** Clear Oak on Maple
- **AMB** Amber on Maple
- **CHY** Cherry on Maple
- **RCL** Royal Cherry on Maple
- **LWL** Light Walnut on Maple
- **ESP** Espresso on Maple
- **MHL** Mahogany on Maple
- **SMK** Smoke on Maple

Edge Details

- (see p. 5)
- **AR** Arc
 - **BV** Bevel
 - **CL** Classic
 - **CV** Cove
 - **EL** Ellipse
 - **FL** Fluted
 - **RD** Radius
 - **RE** Reveal
 - **SQ** Square
 - **TD** Traditional
 - **TR** Transitional

Available Options

- **WG-1** Matte Black Grommet - 1 7/8" diameter I.D. **\$80**
- **WG-2** Matte Black Grommet - 1 7/8" diameter x 4 1/4" I.D. **100**
- **WG-AB** Antique Brass Grommet - 2 1/2" diameter I.D. **120**
- **WG-SN** Satin Nickel Grommet - 2 1/2" diameter I.D. **120**

List Price

To specify, include:

- Model Number
- Wood Finish
- Edge Detail

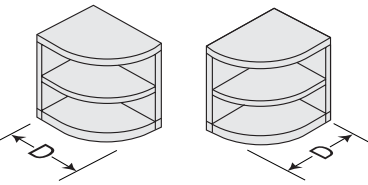
	Model #	Dimensions	List Price	
	<ul style="list-style-type: none"> • One adjustable shelf • Heavy duty 1" shelf • To be used adjacent to units with corresponding depth and height (i.e., 24"D Credenza) • Must specify -LEFT or -RIGHT 	PQQBC2024	20"D x 24"W x 29"H	\$995
		PQQBC2420	24"D x 20"W x 29"H	995
Quarter Round End-Run Bookcase-LEFT				
Quarter Round End-Run Bookcase-RIGHT				

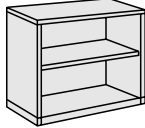
	<ul style="list-style-type: none"> • One adjustable shelf • Heavy duty 1" shelf • Finished back • Bookcases may be ganged 	PGBC29	15" x 36" x 29"H	905

Bookcase

	<ul style="list-style-type: none"> • Two adjustable shelves • Heavy duty 1" shelves • Finished back • Bookcases may be ganged 	PGBC43	15" x 36" x 43 1/2"H	1365

Bookcase

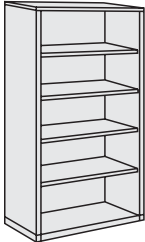
	<ul style="list-style-type: none"> • Four adjustable shelves • Heavy duty 1" shelves • Finished back • Bookcases may be ganged 	PGBC72	15" x 36" x 72"H	2050

Full Height Bookcase

MISCELLANEOUS COMPONENTS

Wood Finishes	Edge Details	Hardware Style	Available Options	List Price
<ul style="list-style-type: none"> CML Clear Maple COL Clear Oak on Maple AMB Amber on Maple CHY Cherry on Maple RCL Royal Cherry on Maple LWL Light Walnut on Maple ESP Espresso on Maple MHL Mahogany on Maple SMK Smoke on Maple 	(see p. 5) <ul style="list-style-type: none"> AR Arc BV Bevel CL Classic CV Cove EL Ellipse FL Fluted RD Radius RE Reveal SQ Square TD Traditional TR Transitional 	(see p. 6 for finishes) <ul style="list-style-type: none"> AR Arc CU Cube HE Heritage OR Orbit SW Swoop TA Tab FP Side-Routed Finger Pull 	<ul style="list-style-type: none"> LK Lock (per pair hinged doors) \$80 WG-1 Matte Black Grommet - 1 7/8" diameter I.D. 80 WG-2 Matte Black Grommet - 1 7/8" diameter x 4 1/4" I.D. 100 WG-AB Antique Brass Grommet - 2 1/2" diameter I.D. 120 WG-SN Satin Nickel Grommet - 2 1/2" diameter I.D. 120 	

To specify, include:

- Model Number
- Wood Finish
- Edge Detail
- Hardware Style
- Hardware Finish



Telephone Table

- Open shelf
- Hinged door storage with one adjustable shelf

Model #	Dimensions	List Price
---------	------------	------------

PG2020TT	20" x 20" x 29"H	\$1255
-----------------	------------------	--------

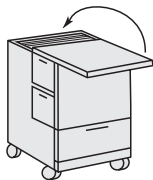

Flip Top Mobile Pedestal

- Includes open file bin, one box drawer, and two CD drawers
- Four dual wheel casters
- May be stored under 29"H worksurfaces
- Includes counter weight to prevent tipping

PGMP-FT	18 1/2" x 22 1/4" x 25 1/4"H	1530
----------------	------------------------------	------



Tray Top Mobile Pedestal

- Includes Box/File drawer and open tray with pencil storage
- Four dual wheel casters
- May be stored under 29"H worksurfaces
- Includes counter weight to prevent tipping
- Optional seat cushion

PGMP-TT	15 1/2" x 20" x 25 1/4"H	1420
PG-CUSH	Optional Seat Cushion 3/4 yd. COM required	+110

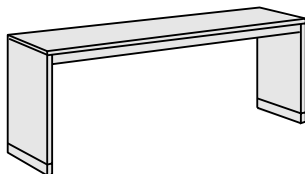

Console Table

- Standard height (CT) or buffet height (BH)

PG2060CT	20" x 60" x 29"H	1945
PG2072CT	20" x 72" x 29"H	2105
PG2060BH	20" x 60" x 36"H	2105
PG2072BH	20" x 72" x 36"H	2275

MISCELLANEOUS COMPONENTS

Wood Finishes

- **CML** Clear Maple
- **COL** Clear Oak on Maple
- **AMB** Amber on Maple
- **CHY** Cherry on Maple
- **RCL** Royal Cherry on Maple
- **LWL** Light Walnut on Maple
- **ESP** Espresso on Maple
- **MHL** Mahogany on Maple
- **SMK** Smoke on Maple

Edge Details

- (see p. 5)
- **AR** Arc
 - **BV** Bevel
 - **CL** Classic
 - **CV** Cove
 - **EL** Ellipse
 - **FL** Fluted
 - **RD** Radius
 - **RE** Reveal
 - **SQ** Square
 - **TD** Traditional
 - **TR** Transitional

Available Options

- **WG-1** Matte Black Grommet - 1 7/8" diameter I.D. **\$80**
- **WG-2** Matte Black Grommet - 1 7/8" diameter x 4 1/4" I.D. **100**
- **WG-AB** Antique Brass Grommet - 2 1/2" diameter I.D. **120**
- **WG-SN** Satin Nickel Grommet - 2 1/2" diameter I.D. **120**

List Price

To specify, include:

- Model Number
- Wood Finish
- Edge Detail

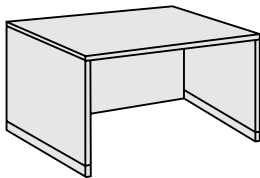

CRT Table

- Optional dual wheel casters

Model #	Dimensions	List Price
PG2436CRT	24" x 36" x 29"H	\$1280
PG3042CRT	30" x 42" x 29"H	1450
PG-CAS	Optional dual wheel casters	365 set

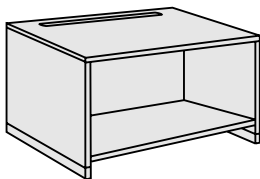

Printer Stand

- Fixed storage shelf
- Paper slot
- Optional dual wheel casters

PG2436PTR	24" x 36" x 29"H	1390
PG3042PTR	30" x 42" x 29"H	1555
PG-CAS	Optional dual wheel casters	365 set

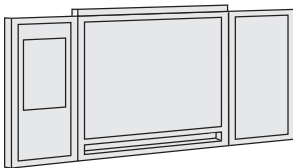

Visual Board

- Doors available with standard veneer, Checkerboard (CH), Diamond (D), Reverse Diamond (RD) patterned veneer, or Birdseye Maple (BE)
- Magnetic porcelain on steel write-on/wipe off surface
- Includes flip chart, two tack panels, four markers, and eraser
- Two tack panels are covered with Maharam Messenger Balsa. COM may **not** be specified
- Optional pull-down projection screen

Standard Maple Veneer Doors:

PG4848VPB	48" x 49 1/2"H	2400
------------------	----------------	------

Checkerboard Patterned Veneer Doors:

PG4848VPB-CH	48" x 49 1/2"H	3115
---------------------	----------------	------

Diamond Patterned Veneer Doors:

PG4848VPB-D	48" x 49 1/2"H	3270
--------------------	----------------	------

Reverse Diamond Patterned Veneer Doors:

PG4848VPB-RD	48" x 49 1/2"H	3270
---------------------	----------------	------

Birdseye Maple Doors:

PG4848VPB-BE	48" x 49 1/2"H	3490
---------------------	----------------	------

PROJ	Pull-Down Projection Screen	+275
-------------	-----------------------------	------

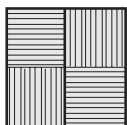

Checkerboard Pattern Doors

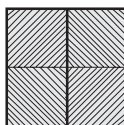

Diamond Pattern Doors

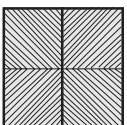

Reverse Diamond Pattern Doors

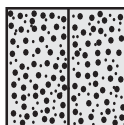

Birdseye Maple Doors

OCCASIONAL TABLES

Wood Finishes

- **CML** Clear Maple
- **COL** Clear Oak on Maple
- **AMB** Amber on Maple
- **CHY** Cherry on Maple
- **RCL** Royal Cherry on Maple
- **LWL** Light Walnut on Maple
- **ESP** Espresso on Maple
- **MHL** Mahogany on Maple
- **SMK** Smoke on Maple

Edge Details

- (see p. 5)
- **AR** Arc
 - **BV** Bevel
 - **CL** Classic
 - **CV** Cove
 - **EL** Ellipse
 - **FL** Fluted
 - **RD** Radius
 - **RE** Reveal
 - **SQ** Square
 - **TD** Traditional
 - **TR** Transitional

To specify, include:

- Model Number
- Wood Finish
- Edge Detail

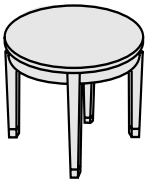
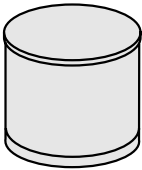
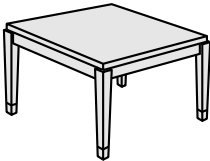
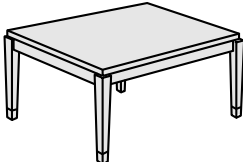
	Model #	Dimensions	List Price
 <p>Side Table</p>	PG24R	20¼" Diameter x 22"H	\$750
 <p>Drum Table</p>	PG24RD	20¼" Diameter x 22"H	860
 <p>Corner Table</p>	PG2424	24" x 24" x 22"H	550
	PG3030	30" x 30" x 22"H	640
 <p>End Table</p>	PG2030	20" x 30" x 22"H	550

OCCASIONAL TABLES

Wood Finishes

- **CML** Clear Maple
- **COL** Clear Oak on Maple
- **AMB** Amber on Maple
- **CHY** Cherry on Maple
- **RCL** Royal Cherry on Maple
- **LWL** Light Walnut on Maple
- **ESP** Espresso on Maple
- **MHL** Mahogany on Maple
- **SMK** Smoke on Maple

Edge Details

- (see p. 5)
- **AR** Arc
 - **BV** Bevel
 - **CL** Classic
 - **CV** Cove
 - **EL** Ellipse
 - **FL** Fluted
 - **RD** Radius
 - **RE** Reveal
 - **SQ** Square
 - **TD** Traditional
 - **TR** Transitional

To specify, include:

- Model Number
- Wood Finish
- Edge Detail

	Model #	Dimensions	List Price
--	---------	------------	------------

PG3030-16

30" x 30" x 16"H

\$615

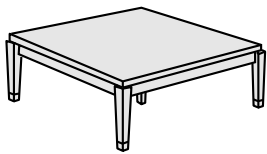

Coffee Table

PG2042-16

20" x 42" x 16"H

640

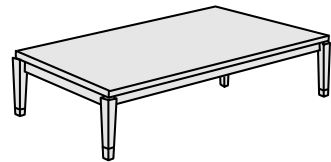

Coffee Table

PG36R-16

36" Diameter x 16"H

1000

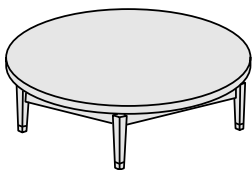

Coffee Table

RECEPTION STATIONS

To specify, include:

- Model Number
- Wood Finish
- Edge Detail
- Hardware Style
- Hardware Finish

Wood Finishes	Edge Details	Hardware Style	Available Options	List Price
<ul style="list-style-type: none"> • CML Clear Maple • COL Clear Oak on Maple • AMB Amber on Maple • CHY Cherry on Maple • RCL Royal Cherry on Maple • LWL Light Walnut on Maple • ESP Espresso on Maple • MHL Mahogany on Maple • SMK Smoke on Maple 	(see p. 5) <ul style="list-style-type: none"> • AR Arc • BV Bevel • CL Classic • CV Cove • EL Ellipse • FL Fluted • RD Radius • RE Reveal • SQ Square • TD Traditional • TR Transitional 	(see p. 6 for finishes) <ul style="list-style-type: none"> • AR Arc • CU Cube • HE Heritage • OR Orbit • SW Swoop • TA Tab • FP Side-Routed Finger Pull 	<ul style="list-style-type: none"> • CD Center Drawer • AK-MP2 Articulating Keyboard Tray • PK2 Pull-Out Keyboard Tray • LK Lock • WG-1 Matte Black Grommet - 1 7/8" diameter I.D. • WG-2 Matte Black Grommet - 1 7/8" diameter x 4 1/4" I.D. • WG-AB Antique Brass Grommet - 2 1/2" diameter I.D. • WG-SN Satin Nickel Grommet - 2 1/2" diameter I.D. (see page 10 for location information) (see page 11-13 for additional accessories) 	<ul style="list-style-type: none"> \$250 470 395 80 80 100 120 120

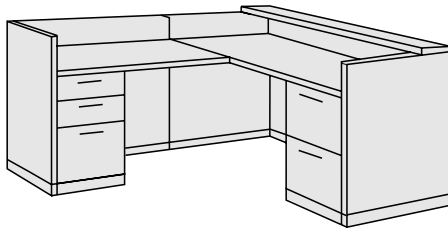

The Reception Station is enclosed by 42"H panels and features a 15"D transaction shelf. L-Shape and U-Shape Configurations are available. L-Shape configurations **must be specified left or right return**. Two styles of Reception Stations are available: Recessed Front and Step Front. The center modesty panel on the Step Front Reception Station can be specified with the standard, all-wood panel, or the optional full metal, perforated wood, or perforated metal (see page 16 for a complete description).

Rectangular transaction tops are standard on the desk front; however, optional wrap-around transaction tops may be specified for the side(s) of the unit. In addition, optional bow-shaped transaction tops are available. A 1/2" floating glass top is offered in both shapes. Floating glass tops are raised above the wood transaction top by satin nickel stand-offs.

NOTE: For custom requirements, please submit drawings and specifications for a factory quote.

	Model #	Dimensions	List Price
<ul style="list-style-type: none"> • Surrounded by 42"H panels • File/File drawers in desk pedestal • Box Box File drawers in return pedestal • Legal width pedestals • Lock included in desk pedestal • Optional transaction tops • Optional center drawer • Must specify left or right return from user side 	PG72RD	Desk: 36" x 72" x 42"H 29"H Worksurface 15"D Transaction Top (Rectangular)	\$8300
		Return: 24" x 48" x 42"H 29"H Worksurface	
	BT	Bow Transaction Top, wood	+300
	WTT	Wrap Around Side Transaction Top, 12"D	+1225
	GLS-TTR	Floating Glass Transaction Top, rectangular	+1550
	GLS-TTB	Floating Glass Transaction Top, bow	+1750

Reception Station, L-Shape Configuration, Recessed Front

<ul style="list-style-type: none"> • Surrounded by 42"H panels • File/File drawers in desk pedestal • Box Box File drawers in return pedestal • Legal width pedestals • Lock included in desk pedestal • Center modesty options • Optional transaction tops • Optional center drawer • Must specify left or right return from user side 	PG72RD-S	Desk: 36" x 72" x 42"H 29"H Worksurface 15"D Transaction Top (Rectangular)	8685	
		Return: 24" x 48" x 42"H 29"H Worksurface		
	BT	Bow Transaction Top, wood	+300	
	WTT	Wrap Around Side Transaction Top, 12"D	+1225	
	GLS-TTR	Floating Glass Transaction Top, rectangular	+1550	
		GLS-TTB	Floating Glass Transaction Top, bow	+1750
		PGRD-PERFWD	Perforated Wood Center Modesty	+700
		PGRD-PERFMTL	Perforated Metal Center Modesty	+795
		PGRD-MTL	Metal Center Modesty	+720
		TWO-TONE	Two-tone finish on modesty panel and transaction top (as shown in brochure)	+110

Reception Station, L-Shape Configuration, Step Front

RECEPTION STATIONS

NOTE: For custom requirements, please submit drawings and specifications for a factory quote.

To specify, include:

- Model Number
- Wood Finish
- Edge Detail
- Hardware Style
- Hardware Finish

Wood Finishes	Edge Details (see p. 5)	Hardware Style (see p. 6 for finishes)	Available Options	List Price
• CML Clear Maple	• AR Arc	• AR Arc	• CD Center Drawer	\$250
• COL Clear Oak on Maple	• BV Bevel	• CU Cube	• AK-MP2 Articulating Keyboard Tray	470
• AMB Amber on Maple	• CL Classic	• HE Heritage	• PK2 Pull-Out Keyboard Tray	395
• CHY Cherry on Maple	• CV Cove	• OR Orbit	• WG-1 Matte Black Grommet - 1 7/8" diameter I.D.	80
• RCL Royal Cherry on Maple	• EL Ellipse	• SW Swoop	• WG-2 Matte Black Grommet - 1 7/8" diameter x 4 1/4" I.D.	100
• LWL Light Walnut on Maple	• FL Fluted	• TA Tab	• WG-AB Antique Brass Grommet - 2 1/2" diameter I.D.	120
• ESP Espresso on Maple	• RD Radius	• FP Side-Routed Finger Pull	• WG-SN Satin Nickel Grommet - 2 1/2" diameter I.D.	120
• MHL Mahogany on Maple	• RE Reveal		(see page 10 for location information)	
• SMK Smoke on Maple	• SQ Square		(see page 11-13 for additional accessories)	
	• TD Traditional			
	• TR Transitional			

	Model #	Dimensions	List Price
<ul style="list-style-type: none"> • Surrounded by 42"H panels • Box Box File drawers in desk pedestal, legal width • Lateral file in rear credenza • Locks included • Optional transaction tops • Optional center drawer • Must specify left or right bridge unit from user side 	PG72RD-U	72"W x 108"D Overall Desk: 36" x 72" x 42"H 29"H Worksurface 15"D Transaction Top (Rectangular) Bridge: 24" x 48" x 42"H 29"H Worksurface Rear Credenza: 24" x 72" 29"H Worksurface	\$10450
	BT	Bow Transaction Top, wood	+300
	WTT108	Wrap Around Side Rear Transaction Top, 12"D	+1225 each
	GLS-TTR	Floating Glass Transaction Top, rectangular	+1550
	GLS-TTB	Floating Glass Transaction Top, bow	+1750

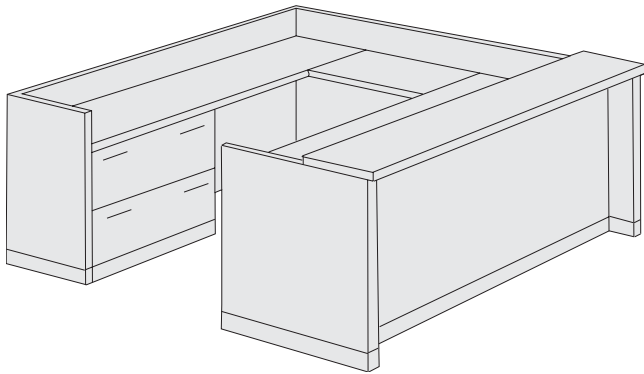

Reception Station, U-Shape Configuration, Side Entry, Recessed Front

<ul style="list-style-type: none"> • Surrounded by 42"H panels • Box Box File drawers in desk pedestal, legal width • Lateral file in rear credenza • Locks included • Center modesty options • Optional transaction tops • Optional center drawer • Must specify left or right bridge unit from user side 	PG72RD-US	72"W x 108"D Overall Desk: 36" x 72" x 42"H 29"H Worksurface 15"D Transaction Top (Rectangular) Bridge: 24" x 48" x 42"H 29"H Worksurface Rear Credenza: 24" x 72" 29"H Worksurface	10800
	BT	Bow Transaction Top, wood	+300
	WTT108	Wrap Around Side Rear Transaction Top, 12"D	+1225 each
	GLS-TTR	Floating Glass Transaction Top, rectangular	+1550
	GLS-TTB	Floating Glass Transaction Top, bow	+1750
	PGRD-PERFWD	Perforated Wood Center Modesty	+700
	PGRD-PERFML	Perforated Metal Center Modesty	+795
	PGRD-MTL	Metal Center Modesty	+720
	TWO-TONE	Two-tone finish on modesty panel and transaction top (as shown in brochure)	+110

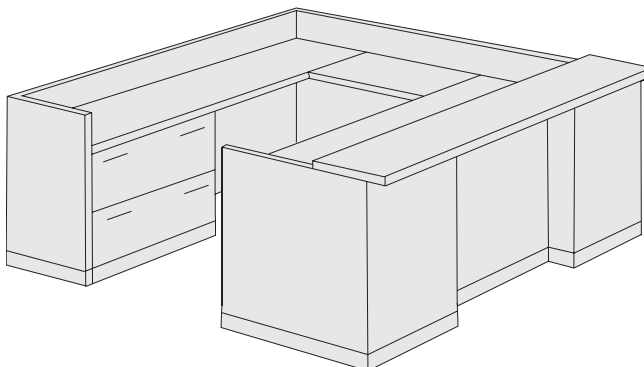

Reception Station, U-Shape Configuration, Side Entry, Step Front

RECEPTION STATIONS

NOTE: For custom requirements, please submit drawings and specifications for a factory quote.

To specify, include:

- Model Number
- Wood Finish
- Edge Detail
- Hardware Style
- Hardware Finish

Wood Finishes	Edge Details	Hardware Style	Available Options	List Price
<ul style="list-style-type: none"> • CML Clear Maple • COL Clear Oak on Maple • AMB Amber on Maple • CHY Cherry on Maple • RCL Royal Cherry on Maple • LWL Light Walnut on Maple • ESP Espresso on Maple • MHL Mahogany on Maple • SMK Smoke on Maple 	(see p. 5) <ul style="list-style-type: none"> • AR Arc • BV Bevel • CL Classic • CV Cove • EL Ellipse • FL Fluted • RD Radius • RE Reveal • SQ Square • TD Traditional • TR Transitional 	(see p. 6 for finishes) <ul style="list-style-type: none"> • AR Arc • CU Cube • HE Heritage • OR Orbit • SW Swoop • TA Tab • FP Side-Routed Finger Pull 	<ul style="list-style-type: none"> • CD Center Drawer • AK-MP2 Articulating Keyboard Tray • PK2 Pull-Out Keyboard Tray • LK Lock (per pedestal) • WG-1 Matte Black Grommet - 1 7/8" diameter I.D. • WG-2 Matte Black Grommet - 1 7/8" diameter x 4 1/4" I.D. • WG-AB Antique Brass Grommet - 2 1/2" diameter I.D. • WG-SN Satin Nickel Grommet - 2 1/2" diameter I.D. (see page 10 for location information) (see page 11-13 for additional accessories)	\$250 470 395 80 80 100 120 120

	Model #	Dimensions	List Price
<ul style="list-style-type: none"> • Surrounded by 42"H panels • Open kneespace in desk • Box Box File drawers in both side units • Legal width pedestals • Center modesty options • Optional transaction tops • Optional center drawer 	PG96RD	96"W x 84"D Overall Center Worksurface: 30" x 48" x 42"H 29"H Worksurface 15"D Transaction Top (Rectangular) Left and Right Side Units: 24" x 84" x 42"H 29"H Worksurface	\$11140
	<ul style="list-style-type: none"> • BT96 Bow Transaction Top, wood +350 • WTT84 Wrap Around Side Transaction Top, 12"D +1225 each • GLS-TTR Floating Glass Transaction Top, rectangular +1700 • GLS-TTB Floating Glass Transaction Top, bow +1900 • PGRD-PERFWD Perforated Wood Center Modesty +700 • PGRD-PERFMTL Perforated Metal Center Modesty +795 • PGRD-MTL Metal Center Modesty +720 • TWO-TONE Two-tone finish on modesty panel and transaction top (as shown in brochure) +110 		

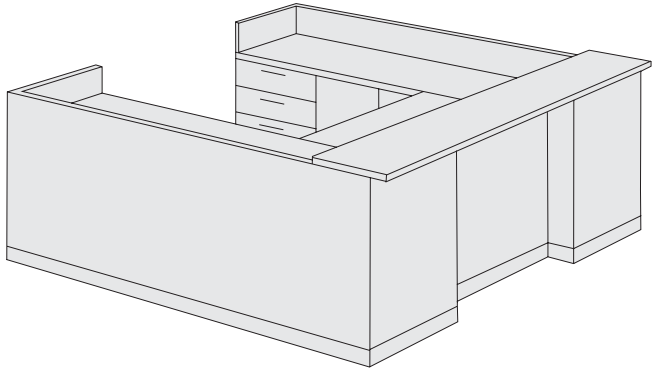

Reception Station, U-Shape Configuration, Rear Entry, Step Front

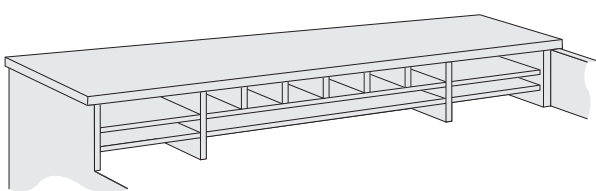

Reception Station Paper Management Organizer

PG72RD-PMO	Fits below front transaction top. May be used with the following reception units: PG6672RD PG6672RD-S PG72RD-U PG72RD-US	1050
-------------------	---	-------------

PG96RD-PMO	Fits below front transaction top. May be used on the PG96RD only	1195
-------------------	---	-------------

NOTES



The Taylor Companies
11020 Santa Fe Ave.
Lynwood CA 90262
Toll Free: 1.888.75TAYLOR

T: 310.631.6727
F: 310.604.3338
E: info@thetaylorcompanies.com
W: thetaylorcompanies.com